

OPERATING INSTRUCTIONS

Dishwasher

EN

DWCBI231.W/1

DWCBI231.S/1

Contents

Your dishwasher	3	How to get the best drying results	18
Welcome to our growing ASKO family!	3	Unloading the dishwasher	19
Safety instructions	4	Program chart	20
Installation	5	Settings	21
Winter storage/Transport	5	Open the dishwasher's Settings menu	21
Overflow guard	5	Care and cleaning	24
Packaging	5	Top up rinse aid	24
Disposal	5	Top up salt	24
Before washing for the first time	6	Cleaning the filters	25
1. Water hardness	6	Cleaning the spray arms	26
2. Basic settings	7	Clean the dishwasher inside and out	27
Greener dishwashing	9	Remove blockages	27
The dishwasher saves energy and water	9	Troubleshooting	29
Loading the dishwasher	10	Installation	35
Fragile dishes	10	Safety instructions	35
Loading affects the results	10	Transport protection for the door	36
The dishwasher's baskets	10	Placing the dishwasher	36
Upper basket	11	Affix the protective film	37
Lower basket	12	Adjust the height and slide the dishwasher into place	37
Cutlery basket	13	Drainage connection	38
Using the dishwasher	15	Connection to water supply	39
Add detergent	15	Electrical connection	40
The main power switch	16	Screwing the dishwasher into place	41
Select program	16	Dishwasher toe kick	42
Starting the dishwasher	17	Service	43
Remaining time	17	Information about your product	43
Status indicator	18	Contact the service department	43
Stopping or changing a program	18	Technical data and energy labelling	44
If you want to load more dishes	18	Technical data	44
If the dishwasher is turned off due to a power failure	18	Information for consumers	44
Once the program has finished	18	Information for test institute	44

Welcome to our growing ASKO family!

We are proud of our appliances. We want them to help make the world a better place – improving quality of life for you and your loved ones. We hope that this appliance will be an appreciated and dependable aid for many years to come.

Please read the operating instructions before use. They include general tips, information about the settings and adjustments you can make, and how best to care for your appliance.

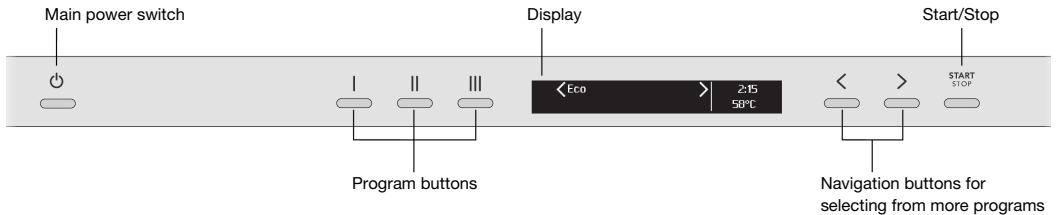

Install the dishwasher, see the chapter *Installation*. Following this, open the door and press the main power switch to start using the machine.

"Welcome to your new ASKO. This is a first time set up." is shown on the display the first time the dishwasher is switched on. It is important that you choose the right settings to ensure good dishwashing results. See page 6.

Safety instructions

- Read the operating instructions and keep them in a safe place!
- Number of standard place settings: 13
- Never use the dishwasher for any purpose other than that specified in these operating instructions.
- Do not load the dishwasher door or dishwasher baskets with anything other than dishes.
- Never leave the dishwasher door open as someone may trip on it.
- Use only dishwasher detergent!
- This machine can be used by children aged 8 and upwards, and by people with reduced physical capacity, mental ability, memory loss or lacking experience and knowledge. These individuals must be supervised when using the machine or have instructions on how to use the machine and understand the risks that can occur. Cleaning of the machine must not be carried out by children without supervision.
- Damaged mains cables must only be replaced by a qualified electrician.
- Only use the dishwasher in household-type environments for dishwashing household dishes. All other use is prohibited.
- Never place dishes with solvent residues in the dishwasher due to the risk of explosion. Nor may dishes that contain ash, wax or lubricants be washed in the dishwasher.
- Children must be watched. Do not allow children to use or play with the dishwasher. Be especially vigilant when the door is open. Some detergent may remain inside! After adding detergent, always start the dishwasher immediately.

WARNING!

Knives and other pointed items must be placed with the points down in the cutlery basket or horizontally in other baskets.

WARNING!

Children must be supervised – dishwasher detergent is corrosive!

Installation

See the chapter *Installation*.

Winter storage/Transport

Store the dishwasher above freezing temperature and avoid long transport distances in very cold weather. Transport the dishwasher upright or laying on its back.

Overflow guard

The overflow protection starts pumping out the water and turns off the water supply if the water level in the dishwasher exceeds the normal level. If the overflow protection is triggered, Overfilling water appears on the display. Turn off the water supply and contact your nearest service centre.

Packaging

The outer packaging protects the product during transport. The packaging material is recyclable. Separate the different packaging materials to help reduce raw material use and waste. Your dealer can take the packaging for recycling or direct you to the nearest recycling centre. The packaging is comprised of:

- Corrugated cardboard made from up to 100% recycled material.
- Expanded polystyrene (EPS) with no added chlorine or fluorine.
- Supports made from untreated wood.
- Protective plastic made from polyethylene (PE).

Disposal

The dishwasher is manufactured and labelled for recycling.

When the dishwasher has reached the end of its service life and is to be disposed of, it should immediately be made unusable. Pull out the power cable and cut it as short as possible.

Contact your local authority for information about where and how your dishwasher should be correctly recycled.

Before washing for the first time

1. Water hardness

In order to achieve good dishwashing results, the dishwasher needs soft water (water with low mineral content). Hard water leaves a white coating on dishes and the dishwasher.

Checking water hardness

Water hardness is specified using the German water hardness scale (°dH) or the French water hardness scale (°fH).

A water supply with a water hardness in excess of 4°dH (6°fH) must be softened. This is done automatically with the aid of the built-in water softener. In order for the water softener to function optimally, it must be adjusted to the hardness of the water supply. Once you have adjusted the water softener, use detergent and rinse aid doses suitable for soft water. test

Contact the local waterworks to check the water hardness in your area.

Make a note of the water hardness: _____

German water hardness scale	French water hardness scale	Recommended setting
0-3°dH	0-5°fH	0
4-5°dH	6-9°fH	1
6-8°dH	10-14°fH	2
9-11°dH	15-20°fH	3
12-14°dH	21-25°fH	4
15-19°dH	26-34°fH	5
20-24°dH	35-43°fH	6
25-29°dH	44-52°fH	7
30-39°dH	53-70°fH	8
40°dH	71°fH	9

If the water hardness exceeds 20°dH (36°fH), we recommend connecting an external water softener.

Increased consumption during regeneration

The dishwasher's built-in water softener is regularly regenerated to maintain its function. Regeneration extends the dishwashing program and increases energy and water consumption. Just how often the dishwasher's water softener is regenerated depends on the selected setting.

Example: If the Ecoprogram is run with a water hardness of 14 °dH (25 °fH), the water softener is regenerated at regular intervals (after 6 dishwashing cycles), energy consumption increases by 0.015 kWh and water consumption increases by 2.3 litres while the program time is extended by 3 minutes. Regeneration occurs during the program's main wash.

WARNING!

Hard water leaves a white coating on dishes and inside the dishwasher. It is therefore important that you select the right setting for the water softener! See Water hardness.

Never run the dishwasher with an empty salt compartment if the water supply has a water hardness in excess of 4°dH (6°fH).

Before washing for the first time

2. Basic settings

Open the door and press the main power switch.

"**Welcome to your new ASKO. This is a first time set up.**" is shown on the display. It is important that you choose the right settings to ensure good dishwashing results.

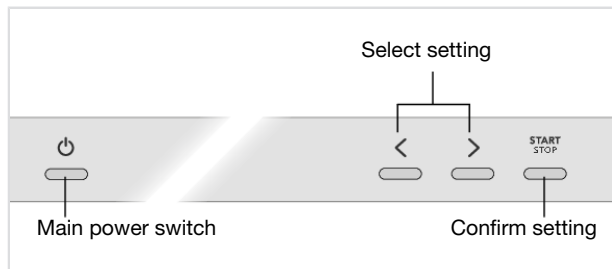

Settings

1. Language

Select the language to be shown on the display.

2. Rinse aid 0/1/2/3/4/5/TAB

Drying is faster and a better result is achieved if you use rinse aid. You will also achieve a better dishwashing result with clear and spotless dishes.

Select rinse aid dosage. The rinse aid dispenser can be adjusted between 0 (Off) and 5 (High dosage).

When using an all-in-one detergent that contains rinse aid, you can activate the setting TAB. Read more about all-in-one detergent in the chapter *Using the dishwasher*.

Pre-selected at factory: 5

💧 Top up rinse aid

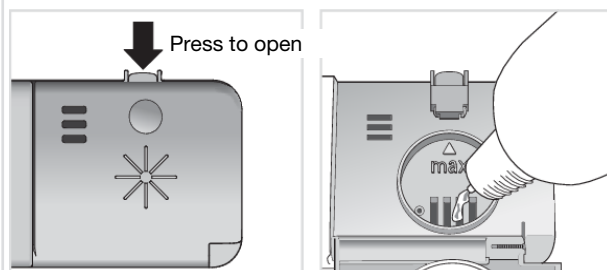

1. Open the rinse aid compartment lid.
2. Carefully top up with rinse aid to the level marked **max**.
3. Wipe up any splashes of rinse aid around the compartment.
4. Close the lid firmly.

Before washing for the first time

3. **Water hardness** 0/1/2/3/4/5/6/7/8/9

Adjusting the water softener. Select a setting depending on the hardness of the water supply. It is important that this setting is correct!

Do not forget to put salt in the salt compartment after you have set the water softener to 1 - 9.

For a water supply with a hardness under 4°dH (6°fH), select 0. The water softener is deactivated and no salt is needed.

Pre-selected at factory: 6

☆ Top up salt

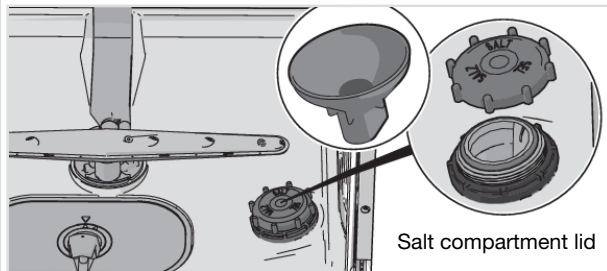

1. Unscrew the salt compartment lid.
2. Place the funnel supplied with the dishwasher in the salt compartment top-up hole. First, pour in about 1 l of water.
3. Then add salt, a maximum of 630 gram, until the compartment is full. Use large grain salt or special dishwasher salt.
4. Wipe up any excess salt so that the lid can be screwed on firmly.

In order to avoid rust stains a dishwashing program must be started immediately after adding salt.

To change the selected setting, see the chapter Settings.

The dishwasher saves energy and water

When using a dishwasher in a residential setting, less energy and water are generally used compared to washing the dishes by hand.

Do not rinse under running water

Do not rinse the dishes under running water as this will lead to increased energy and water consumption. Simply scrape off large food particles before loading the dishwasher.

Choose a green detergent

Read the environmental declaration on the packaging!

Too much detergent, rinse aid and salt can result in less effective dishwashing and also entail greater environmental impact.

Run a fully loaded dishwasher

Save energy and water by waiting until the dishwasher is full before running a program (see number of standard place settings). Use the Rinse and hold program to rinse the dishes if there are any unpleasant odours.

Run programs at a lower temperature

If the dishes are only slightly dirty, you can select a program with a low temperature.

Select dishwashing program – Eco

This program is suitable for washing normally soiled dishes and is the most effective program in terms of combined energy and water consumption. This program is used to assess compliance with EU legislation on ecodesign.

The dishwashing program is designed for an effective wash using as little energy and water as possible. The program washes at a low temperature for a long time.

Open the door a little once the program has finished

Better drying results are achieved if you open the door a little once the program has ended. (If the dishwasher is built-in the surrounding furnishings must be resistant to any condensation from the dishwasher.)

Connect to cold water

Connect the dishwasher to the cold water supply if the building is heated using oil, electricity or gas.

Connection to hot water supply

Connect the dishwasher to the hot water supply (max. 70 °C) if the building is heated using an energy-efficient means such as district heating, solar power or geothermal power. Choosing a hot water connection cuts dishwashing times and reduces the dishwasher's energy consumption.

NOTE!

Do not exceed the permitted water supply temperature. Certain materials used in some cookware cannot withstand strong heat.

Loading the dishwasher

Fragile dishes

Some cookware is not dishwasher safe. This can be for several reasons. Some materials cannot withstand strong heat, others can be damaged by dishwashing detergent.

Exercise caution with, for example, handmade items, fragile decoration, crystal/glassware, silver, copper, tin, aluminium, wood and plastic. Look for the "Dishwasher safe" marking.

Fragile decoration

Porcelain with decoration on top of the glazing (the items feel rough) should not be washed in a dishwasher.

Crystal/Glass

Wash fragile items made of crystal/glass, such as crystal glass from Orrefors, using the gentle dishwashing program Crystal glass. Remember to use a small amount of detergent and to place items so that they do not touch each other during the wash.

Drying is faster and a better result is achieved if you use rinse aid. You will also achieve a better dishwashing result with clear and spotless dishes.

Hand-painted glassware, as well as antique and very fragile items, should not be washed in a dishwasher.

Silver

Silver and stainless steel items should not come into contact, as the silver can become discoloured.

Aluminium

Aluminium can lose its shine if washed in a dishwasher. However, good quality aluminium pans can be washed in a dishwasher, even if some of the shine will be lost.

Cutlery with glued handles

Some types of glue are not dishwasher safe. In such cases, the handles may loosen.

Loading affects the results

Load the dishes carefully to ensure the best washing and drying results with the lowest possible energy and water consumption. Give your dishwasher the best chance to reach and clean all surfaces, as well as to dry the dishes as thoroughly as possible.

- All dirty surfaces should face inwards and downwards!
- Dishes should not be placed in or on each other.
- Angle dishes with hollows, such as cups, so that the rinse water will run off. This is also important for plastic items.
- Make sure small items cannot fall through the dishwasher basket; place them in the cutlery basket.

NOTE!

Check that the spray arms can rotate freely.

The dishwasher's baskets

The dishwasher is equipped with an upper basket and a lower basket with a cutlery basket.

The appearance of the baskets may differ depending on the dishwasher setup.

Upper basket

Place glasses, cups, bowls, side plates and saucers in the upper basket. All dirty surfaces should face inwards and downwards! Wine glasses are placed on the wine glass shelf and knives are placed in the knife stand on the right.

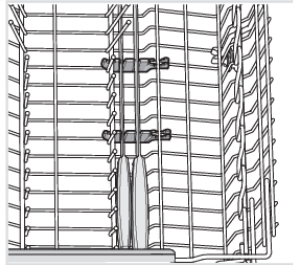
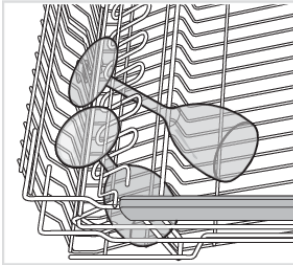
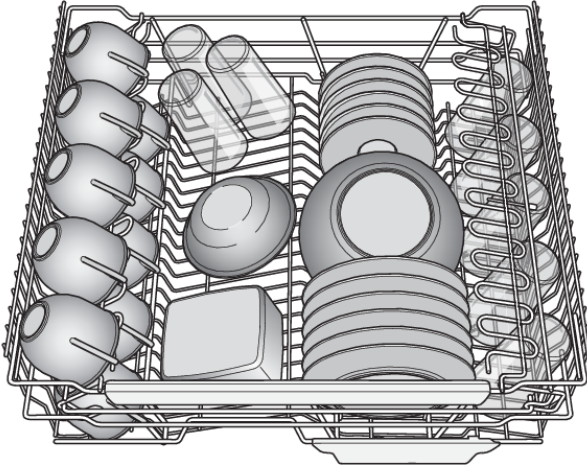

Raising the upper basket

1. Pull out the upper basket.
2. Grab the sides of the upper basket with both hands and lift it up.

Lowering the upper basket

1. Pull out the upper basket.
2. Pull out the two locking handles on either side to lower the upper basket.

Loading the dishwasher

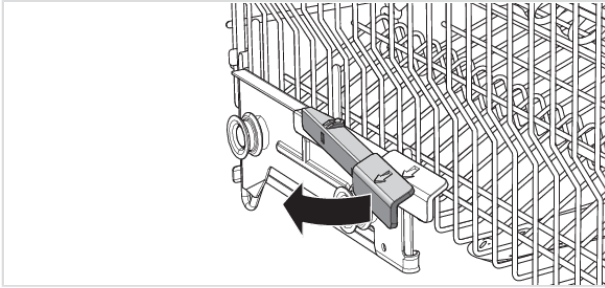

Lower basket

Place plates, side plates, serving dishes, pots and cutlery (in the cutlery basket) in the lower basket.

Place pots and pans in the rear right of the lower basket to best utilise dishwashing performance from the rear spray nozzle (WideSpray™), which is intended for these types of dishes.

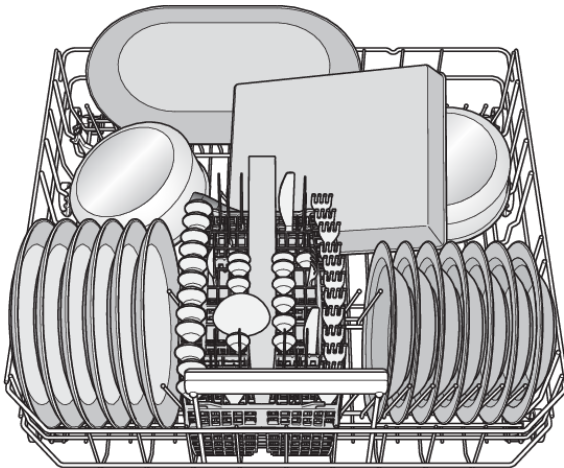

Foldable tines

Lower the foldable tines (plate supports) when washing pots. Release the foldable tines by pressing the catch inwards before adjusting their position.

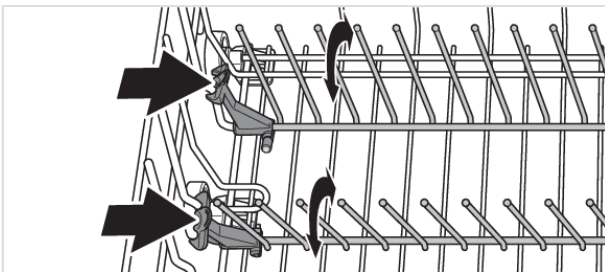

Washing large plates

Move foldable tines and their mounts to widen the distance between the tine rows to adapt the lower basket to plates with a diameter greater than 25 cm.

Accessory

Buy a wine glass shelf with space for six tall¹⁾ wine glasses. The wine glass shelf is designed to ensure optimal washing and drying results with tall wine glasses. The wine glass shelf is placed in the rear section of the lower basket. This accessory is available where you bought the dishwasher.

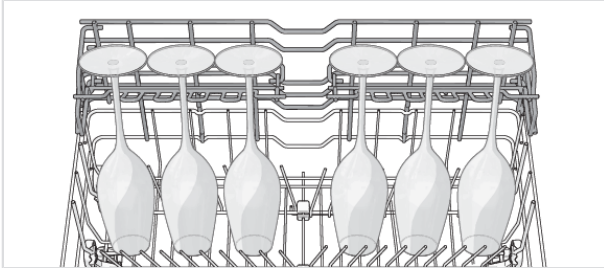

Cutlery basket

Place cutlery with the handles facing down, except for knives, and spread them out as much as possible. Ensure that spoons do not stack inside each other.

The cutlery basket is best placed in the middle at the front of the lower basket to best utilise dishwashing performance from the unique spray nozzle (Power Zone Cutlery™), which is intended for the cutlery basket.

⚠ WARNING!

Knives and other pointed items must be placed with the points down in the cutlery basket or horizontally in other baskets.

Fold-down section for small items

The cutlery basket has a fold-down section in the middle for small items, or small shafts, such as electric whisk attachments.

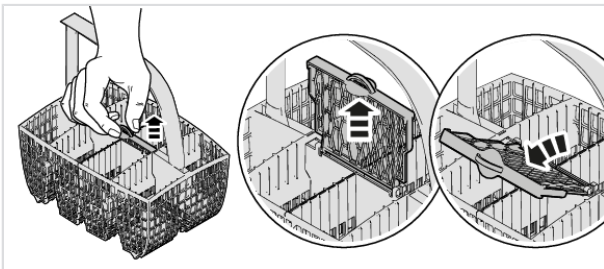

¹⁾ Height: max. 25 cm, Diameter: max. 7.5 cm

Loading the dishwasher

Cutlery basket with lid

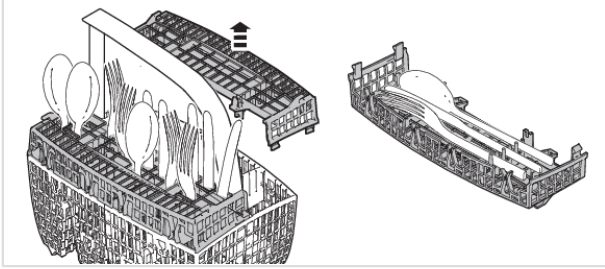

Accessory

Buy an extra cutlery basket. The extra cutlery basket is flexible and can be dismantled and attached to the lower basket or the large cutlery basket to make an extra large cutlery basket. This accessory is available where you bought the dishwasher.

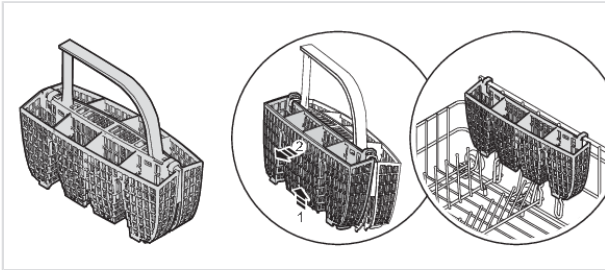

Add detergent

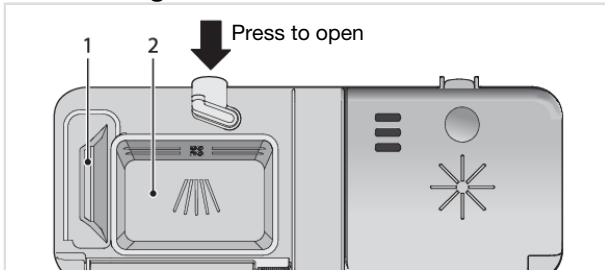

1. Prewash detergent compartment
2. Main wash detergent compartment

Detergent is added according to water hardness.

Follow the instructions on the detergent packaging. This dishwasher is fitted with a water softener, so use detergent and rinse aid doses suitable for soft water.

Too much detergent can result in less effective dishwashing and also entails greater environmental impact.

The detergent compartment must be dry when adding detergent. There is one compartment for the prewash and one for the main wash. If powder or liquid dishwasher detergent is used, add a small amount of the detergent to the prewash compartment. Contact the detergent manufacturer if you have questions about the detergent.

NOTE!

Use only dishwasher detergent! Washing up liquid must not be used as the foam that forms prevents the dishwasher from operating effectively.

Dishwasher tablets

Halve the tablet if it is difficult to close the dispenser lid. There is a risk that the detergent will not be released properly if the lid is tight and will not open correctly.

NOTE!

Dishwasher tablets are not recommended for short programs (less than 75 minutes). Use powder or liquid dishwasher detergent instead.

All-in-one detergent

There are many types of all-in-one detergents on the market. Read through the directions for these products carefully.

When using an all-in-one detergent that contains rinse aid, you can activate the setting TAB. Note that the salt compartment must be filled with salt.

NOTE!

Optimal washing and drying results are achieved by using normal detergent together with separately dispensed rinse aid and salt.

Using the dishwasher

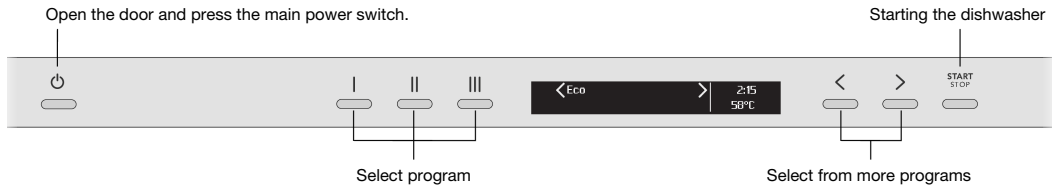

The main power switch

Open the door and press the main power switch. Also turn on the water tap if it is turned off.

Select program

Eco is always pre-selected. To select another program, press one of the program buttons I, II or III. You can also select a program by pressing the navigation button < or > until the desired program is shown on the display.

Select a program to suit the type of dishes and how dirty they are.

Eco

This program is suitable for washing normally soiled dishes and is the most effective program in terms of combined energy and water consumption. This program is used to assess compliance with EU legislation on ecodesign.

Crystal glass

This program is intended for washing fragile glasses that have just been used and so do not require a particularly powerful program. Porcelain can also be washed. See also *Fragile dishes* in the chapter *Loading the dishwasher*.

Intensive

A program with a high temperature to dissolve grease on very dirty dishes, such as pans, casserole dishes and oven dishes. If these dishes do not completely fill the dishwasher, you can add plates and the like.

Quick

This program is used for glasses and porcelain that is slightly dirty, such as coffee cups.

Rinse and hold

Used to rinse dishes while you wait for the dishwasher to become fully loaded.

Universal²⁾

Powerful programme for daily use that can remove dried leftovers, but is not intended for burnt food, such as on oven dishes.

|| SANI²⁾

This program is ideal to use when hygiene demands are set high. The temperature of the main wash is 60 °C. The final rinse is 85 °C for 4 minutes.

||| SANI Quick²⁾

Select SANI Quick if you want a quicker program that still fulfils hygiene demands. The temperature of the main wash is 60 °C. The final rinse is 85 °C for 4 minutes.

Self-cleaning

Self-cleaning program for hygienic cleaning of the dishwasher tub, spray arms and spray pipes.

This program should be run (with no dishes in the machine) using normal dishwasher detergent or citric acid. Special dishwasher cleaners are also available on the market. For the removal of limescale deposits, see *Dishwasher tub* in the chapter *Care and cleaning*.

START STOP Starting the dishwasher

Press Start/Stop until the display shows "Program started, close door". This indicates that the dishwasher is ready to start. Close the door properly, otherwise the dishwasher will not start.

If the dishwasher is not started or the door is not closed within 2 minutes of the last button press, the machine switches off.

Remaining time

Once you have chosen a program, the time the programme took when last used is displayed.

Once you have started the dishwasher the display shows the remaining program time. The remaining time is updated after the water for the final rinse has been heated.

This may differ somewhat from time to time depending on the temperature of the water supply, the amount of dishes, the ambient temperature and other factors.

During the first run of each program, the remaining time displayed can be slightly misleading, as the dishwasher is estimating the time. When you run the program a second time, the dishwasher will calculate the remaining time based on the previous duration of the program.



²⁾ Program button I / II / III. The programs pre-assigned to the program buttons can be changed. See the chapter *Settings*.

Using the dishwasher

Status indicator

The status indicator on the front display provides information by means of different colours.

Blue - Load more

The program has started, but you can still load more dishes.

Red - Do not load

You should not load more dishes (risk of poorer dishwashing result).

A flashing light indicates that the door has been opened while a program is in progress. If it flashes when the door is closed, an error has occurred. See the chapter Troubleshooting.

Green - Unload

The dishwashing program is finished. The status light stays on for 15 minutes.

Stopping or changing a program

If you want to change program after starting the dishwasher, open the door then press and hold Start/Stop for three seconds. Add more detergent if the lid of the detergent dispenser has opened. Then select a new program, press Start/Stop and close the door.

If you want to load more dishes

Open the door. The dishwasher stops automatically. Add the dishes and close the door. After a while, the dishwasher continues the program.

If the dishwasher is turned off due to a power failure

If the dishwashing program was not finished, the interrupted program continues when power is restored.

NOTE!

During drying, the program is interrupted if the power is cut or the door is open for more than 2 minutes.

Once the program has finished

Once the program has finished, "END" appears on the display.

At the end of the program one short signal will sound. Chapter *Settings* describes how to change this function.

The dishwasher switches off automatically after the program ends. Shut off the water tap after each use.

How to get the best drying results

- Fully load the dishwasher.
- Angle dishes with hollows, such as cups, so that the rinse water will run off. This is also important for plastic items.
- Top up with rinse aid or increase the rinse aid dosage level.
- Open the door a little once the program has finished.
- Allow the dishes to cool before unloading the dishwasher.

Unloading the dishwasher

Hot porcelain is more fragile. Leave the dishes to cool in the dishwasher before unloading them.

Unload the lower basket first to avoid any water drops from the upper basket falling onto the dishes in the lower basket.

Using the dishwasher

Program chart

Program	Prewashes	Main wash	Number of rinses	Final rinse	Consumption values ¹⁾						
					Cold water ²⁾			Hot water ³⁾			Water cons. (liter)
					Dishwashing time (approx. hrs:min)	Energy (approx. kWh)	Dishwashing time (approx. hrs:min)	Energy (approx. kWh)			
Eco ⁴⁾	0	50 °C	2	56 °C	3:50	0.92	3:30	0.6	9.9		
Crystal glass		45 °C	2	50 °C	1:40	0.7	1:20	0.4	9.0		
Intensive	2	70 °C	2	70 °C	2:55	1.6	2:35	1.2	16.5		
Quick	0	<35 °C	2	<25 °C	0:20	0.2	0:20	0.1	9.5		
Rinse and hold			1	--- °C	0:07	0.01	0:07	0.01	3.0		
Universal	2	60 °C	2	65 °C	2:05	1.2	1:45	0.8	15.5		
SANI	1	60 °C	2	85 °C	1:35	1.7	1:20	1.2	13.0		
SANI Quick	1	60 °C	2	85 °C	1:00	1.9	0:45	1.3	15.5		
Self-cleaning		70 °C	2	85 °C	1:15	1.6	0:55	1.4	9.0		

1) Consumption values vary depending on the temperature of the incoming water, room temperature, load size, selected additional functions and more.



2) Connection to cold water, approx. 15 °C.

3) Connection to hot water, approx. 60 °C.

4) This program is suitable for washing normally soiled dishes and is the most effective program in terms of combined energy and water consumption. This program is used to assess compliance with EU legislation on ecodesign.

Open the dishwasher's Settings menu

Open the door and press the main power switch until the display lights up.

To open the dishwasher's Settings menu, press the Navigation buttons:  x 3,  x 3

To exit the dishwasher's Settings menu, select Exit and confirm your selection with Start/Stop.

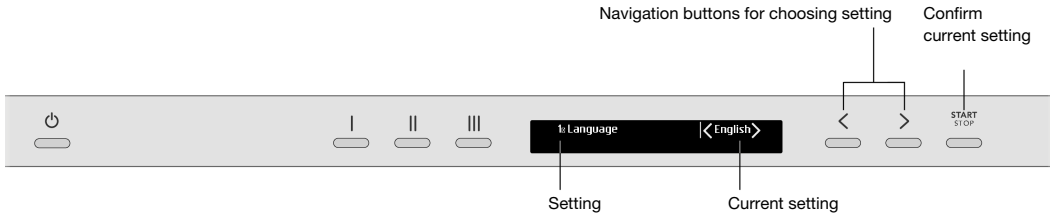

Settings	Alternatives	
1. Language	<i>English/Svenska/Dansk/ Norsk/Suomi/Nederlands/ Français/Deutsch/Italiano/ Русский/Español/ Português/Sloven./ Eesti/Latviešu/Lietuvių/ Hrvatski/Polish/ 简体中文 / 繁體中文 / 日本語</i>	You can choose the language used for the display.
2. Select programs	Eco (On/Off / I / II / III) Crystal glass Intensive Quick Rinse and hold SANI SANI Quick Self-cleaning	<i>On/Off / I / II / III</i> Programs can be shown or hidden in the menu. Choose between On and Off. (Eco cannot be hidden in the menu.) Programs are pre-assigned to the program buttons; I Universal II SANI III SANI Quick To change the programs assigned to the buttons, select the desired program from the menu and then select I, II or III.
3. Child lock	<i>On/Off</i>	You can activate the child lock (button lock) to prevent children from starting the dishwasher. I > To temporarily deactivate and activate the child lock, press and hold Program button I and the right Navigation button for three seconds.

Settings

Settings	Alternatives	
4. Display settings	Contrast top display 1/2/3/4 Logo in top display <i>On/Off</i> Info in front display 1/2	For adjusting the contrast of the top display. Setting to hide the logo shown on the display. You can choose the information that is shown on the front display. 1 Status indicator Time left ³⁾ <i>Off</i> 2 Status indicator Time left+Status ⁴⁾ <i>On</i>
5. Feedback sound	<i>0/1/2/3</i>	This sound is used to confirm each button press.
6. Buzzer volume	<i>0/1/2/3</i>	The buzzer indicates when a dishwashing program has ended. <i>Error messages are always indicated by a loud buzzer.</i>
7. Rinse aid 	<i>0/1/2/3/4/5/TAB</i>	Setting for rinse aid dosage. The rinse aid dispenser can be adjusted between 0 (Off) and 5 (High dosage). Increase the rinse aid dosage: <ul style="list-style-type: none"> • If the dishes have water marks. Decrease the rinse aid dosage: <ul style="list-style-type: none"> • If the dishes have a sticky white/blue film. • If the dishes are streaked. • Build-up of foam. If you have very soft water, the rinse aid can be diluted 50:50 with water. When using an all-in-one detergent that contains rinse aid, you can activate the setting TAB.
8. Temperature unit	<i>°C/°F</i>	Temperatures can be displayed in °C (Celsius) or °F (Fahrenheit).

³⁾ SANI, SANI Quick: Time left+Status

⁴⁾ SANI, SANI Quick: Time left+Status+Temperature

Settings		Alternatives																																		
9.	Water hardness	0/1/2/3/4/5/6/7/8/9	Adjusting the water softener. Select a setting depending on the hardness of the water supply. It is important that this setting is correct!																																	
			<table border="1"> <thead> <tr> <th>German water hardness scale</th> <th>French water hardness scale</th> <th>Recommended setting</th> </tr> </thead> <tbody> <tr> <td>0-3°dH</td> <td>0-5°fH</td> <td>0</td> </tr> <tr> <td>4-5°dH</td> <td>6-9°fH</td> <td>1</td> </tr> <tr> <td>6-8°dH</td> <td>10-14°fH</td> <td>2</td> </tr> <tr> <td>9-11°dH</td> <td>15-20°fH</td> <td>3</td> </tr> <tr> <td>12-14°dH</td> <td>21-25°fH</td> <td>4</td> </tr> <tr> <td>15-19°dH</td> <td>26-34°fH</td> <td>5</td> </tr> <tr> <td>20-24°dH</td> <td>35-43°fH</td> <td>6</td> </tr> <tr> <td>25-29°dH</td> <td>44-52°fH</td> <td>7</td> </tr> <tr> <td>30-39°dH</td> <td>53-70°fH</td> <td>8</td> </tr> <tr> <td>40°dH</td> <td>71°fH</td> <td>9</td> </tr> </tbody> </table>	German water hardness scale	French water hardness scale	Recommended setting	0-3°dH	0-5°fH	0	4-5°dH	6-9°fH	1	6-8°dH	10-14°fH	2	9-11°dH	15-20°fH	3	12-14°dH	21-25°fH	4	15-19°dH	26-34°fH	5	20-24°dH	35-43°fH	6	25-29°dH	44-52°fH	7	30-39°dH	53-70°fH	8	40°dH	71°fH	9
			German water hardness scale	French water hardness scale	Recommended setting																															
			0-3°dH	0-5°fH	0																															
			4-5°dH	6-9°fH	1																															
			6-8°dH	10-14°fH	2																															
			9-11°dH	15-20°fH	3																															
			12-14°dH	21-25°fH	4																															
			15-19°dH	26-34°fH	5																															
			20-24°dH	35-43°fH	6																															
			25-29°dH	44-52°fH	7																															
30-39°dH	53-70°fH	8																																		
40°dH	71°fH	9																																		
Do not forget to put salt in the salt compartment after you have set the water softener to 1 - 9.																																				
<i>For a water supply with a hardness under 4°dH (6°fH), select 0. The water softener is deactivated and no salt is needed.</i>																																				
10.	Interior light at power off	On/Off	Select whether the interior light is to be switched on when the dishwasher is turned off and the door is opened. (If the main power switch is turned on, the interior light is always switched on when the door is opened.)																																	
			To exit the dishwasher's Settings menu, select Exit and confirm your selection with Start/Stop.																																	
	Exit																																			

Care and cleaning

💧 Top up rinse aid

When the rinse aid needs topping up, the above symbol lights on the display.

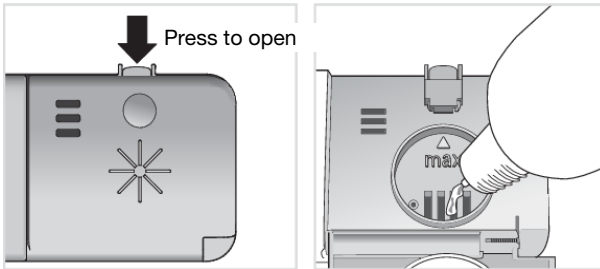

1. Open the rinse aid compartment lid.
2. Carefully top up with rinse aid to the level marked **max.**
3. Wipe up any splashes of rinse aid around the compartment.
4. Close the lid firmly.

After topping up, it may take a while before the symbol goes out.

✳️ Top up salt

When the salt needs topping up, the above symbol lights on the display.

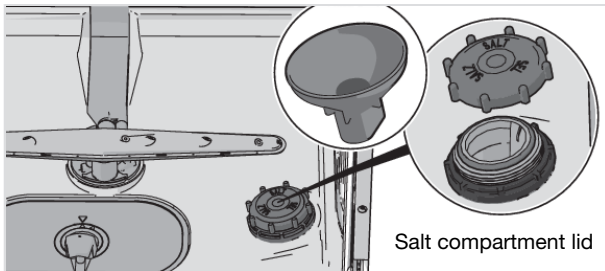

1. Unscrew the salt compartment lid.
2. Place the funnel supplied with the dishwasher in the salt compartment top-up hole. (Water is only needed the first time.)
3. Then add salt, a maximum of 630 gram, until the compartment is full. Use large grain salt or special dishwasher salt.
4. Wipe up any excess salt so that the lid can be screwed on firmly.

After topping up, it may take a while before the symbol goes out.

⚠️ WARNING!

In order to avoid rust stains a dishwashing program must be started immediately after adding salt.

Never pour dishwasher detergent into the salt compartment. This destroys the water softener!

Cleaning the filters

Coarse filter

The coarse filter traps larger food particles, which cannot get past the drainage pump. Empty the coarse filter when necessary. It should be cleaned at regular intervals depending on how often the dishwasher is used.

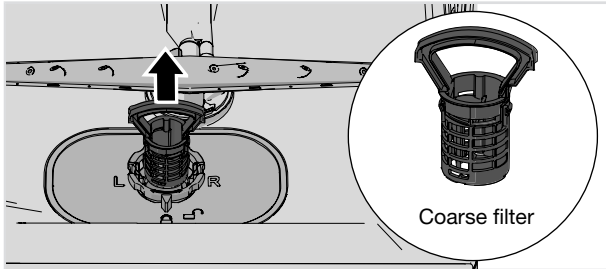

1. Lift the coarse filter by the handle.
2. Empty the coarse filter.
3. Refit the coarse filter. Press it down until it clicks into place.

Fine filter

Debris that collects on the fine filter is automatically rinsed away during each wash. Clean the fine filter when necessary. It should be cleaned at regular intervals depending on how often the dishwasher is used.

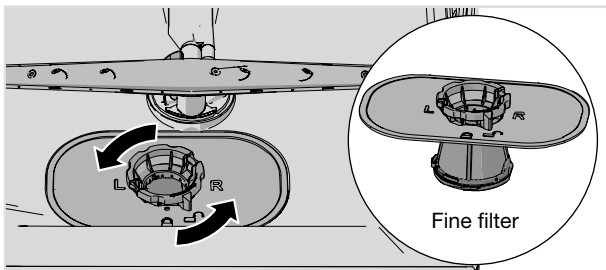

1. Turn the locking ring anticlockwise and lift the fine filter straight up.
2. Clean the fine filter.
3. Refit the fine filter and turn the locking ring clockwise to its stop position. Check that the edges seal properly.

Remember to refit the coarse filter!

Care and cleaning

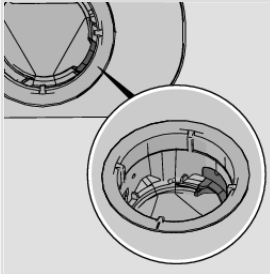

Check that the coloured stop on the right in the bottom drain is in place.

NOTE!

Dishwashing results may be affected if the coarse and fine filters are incorrectly fitted. The dishwasher must not be used without the filters in place!

Cleaning the spray arms

Holes and bearings can sometimes become blocked. Remove any debris using a pin or the like. The spray arms also have holes underneath.

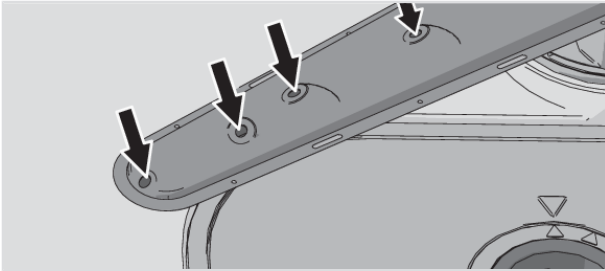

To facilitate cleaning you can remove the spray arms. Remember to fit them firmly back into place afterwards.

Upper spray arm

1. Pull out the upper basket.
2. Unscrew the spray arm bearings counterclockwise to remove the spray arm from the upper basket.

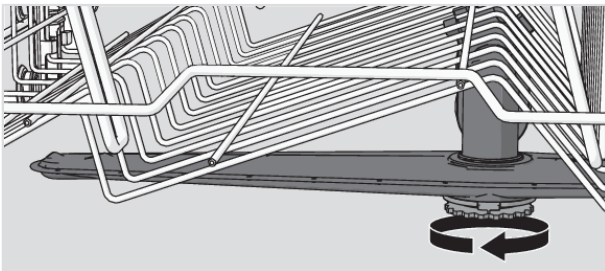

Lower spray arm

- Pull the lower spray arm straight up to release it.

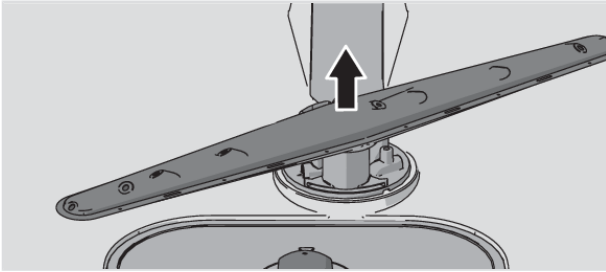

Clean the dishwasher inside and out

Door and door seal

Open the door. Clean the sides of the door and the door seal regularly with a slightly damp cloth. Clean the door seal at the lower front edge of the dishwasher with a washing-up brush.

Display and buttons

Keep the display and the buttons clean. If necessary, wipe them with a dry or slightly damp cloth. Never use cleaning products – they may scratch the surface.

Use the main power switch to switch off the dishwasher when cleaning the buttons to avoid activating them inadvertently.

Dishwasher tub

The dishwasher tub is made of stainless steel and is kept clean through normal use (when used regularly).

If you have hard water, limescale deposits may build up in the dishwasher. If this happens, run the Self-cleaning program with two tablespoons of citric acid in the detergent compartment (with no dishes in the machine). Special dishwasher cleaners are also available on the market.

Remove blockages

Unblocking the drainage pump

If the dishwasher still contains water after the program has finished, something may be blocking the drainage pump. Such blockages are easily removed.

1. Turn off the machine using the main power switch and unplug it from the wall socket.
2. Remove the coarse filter and the fine filter.
3. Scoop out the water from the dishwasher tub.
4. In order to inspect the drainage pump, remove the coloured stop on the right in the bottom drain.
5. Turn the pump wheel located behind the drainage pump stop by hand. Carefully remove any items.
6. Refit the drainage pump stop along with the fine and coarse filters.
7. Plug the machine in again.

If the dishwasher still does not start and a whirring sound is heard, the overflow protection has been activated.

Care and cleaning

- Shut off the water.
- Remove the plug from the wall socket.
- Call the service department.

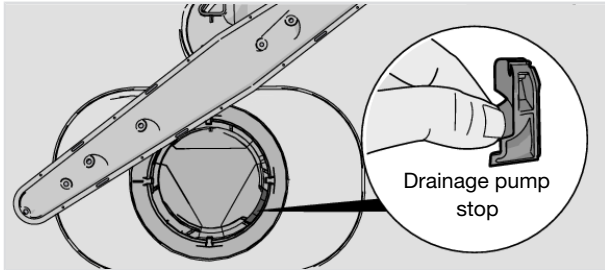

NOTE!

Do not forget to refit the drainage pump stop.

Unblocking the inlet hose filter

If the water supply contains small particles, the outer filter on the inlet hose may become blocked, which results in Water inlet fault.

1. Turn off the machine using the main power switch and unplug it from the wall socket.
2. Turn off the water tap.
3. Unscrew the inlet hose.
4. Carefully remove the outer filter from the inlet hose and clean it.
5. Refit the filter and check that the gasket is correctly positioned.
6. Screw the inlet hose firmly into place.
7. Plug the machine into the wall socket and turn on the water tap. Allow the pressure to settle for a while and check that the connection is watertight.

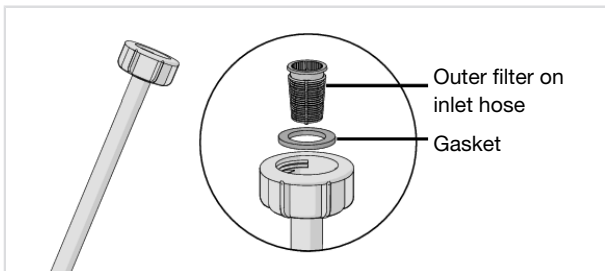

Type of fault on the display		Action
F10	Overfilling water 1	Clear the drainage pump. See the chapter <i>Care and cleaning</i> . If the problem persists, call the service department.
F11	Water outlet fault	See "Water remains in the dishwasher" in the table "Problem" below. If the problem persists, call the service department.
F12	Water inlet fault	Check that the water tap is on. Check that the outer filter on the inlet hose is not blocked. See <i>Unblocking the inlet hose filter</i> in the chapter <i>Care and cleaning</i> . If the problem persists, call the service department.
F40	Inlet valve leakage	Turn off the water tap and call the service department.
F41	Heater fault	Remove the plug from the wall socket and call the service department.
F52	Clean the filters (Water level fault)	Clean the coarse and fine filters. Check that the outer filter on the inlet hose is not blocked. If the problem persists, call the service department.
F54	Overfilling water 2	Turn off the water tap and call the service department.
F56	Circ. pump fault	Call the service department.
F67	Water inlet fault	Check that the water tap is on. Check that the outer filter on the inlet hose is not blocked. See <i>Unblocking the inlet hose filter</i> in the chapter <i>Care and cleaning</i> . If the problem persists, call the service department.

Press any button to clear the error message.

Problem	Possible causes	Action
The buttons do not react when pressed.	You have pressed the buttons too soon after opening the door.	Wait a moment then try again.
	Child lock (button lock) activated.	See the chapter <i>Settings</i> .
	The door is closed.	Open the door. The buttons only react to use when the door is open.
	The buttons are dirty.	Clean with a dry or slightly damp cloth.
Cannot close door.	The baskets are not correctly positioned.	Check that the baskets are correctly positioned horizontally.
		Check that the dishes are not blocking the baskets from sliding properly into place.

Troubleshooting

Problem	Possible causes	Action
The dishwasher does not start.	The Start/Stop start button has been pressed for too short a time.	Press and hold Start/Stop until the display shows "Program started, close door".
	The door is not properly closed.	Check.
	You have opened the dishwasher to add more dishes while a program is in progress.	Close the door and wait. After a while, the dishwasher continues the program.
	A fuse/circuit breaker has been tripped.	Check.
	The plug is not plugged into the wall socket.	Check.
	The water tap is turned off.	Check.
	Overflow/leaks.	Check.
	A whirring sound (the drainage pump) is heard from the dishwasher and does not stop when the main power switch is turned off.	Turn off the water tap. Pull out the plug and call the service department.

Problem	Possible causes	Action
The dishes are not clean.	The spray arms do not rotate.	Check that the dishes are not blocking the spray arms.
	Spray arm holes or bearings blocked.	Clean the spray arms. See the chapter <i>Care and cleaning</i> .
	Unsuitable dishwashing program.	Select a program with a high temperature to dissolve grease on very dirty dishes, such as Intensive.
	Incorrect detergent dosage.	Dose according to water hardness. Far too much or far too little detergent results in poorer dishwashing results.
	Old detergent. Detergent is a perishable product.	Avoid large packages.
	Dishes loaded incorrectly.	Do not cover porcelain with large bowls or the like. Avoid placing very tall glasses in the corners of the baskets.
	Glasses and cups have toppled over during the program.	Place dishes to sit steady.
	The filters are not fitted correctly.	Check that the filter handle is locked in the stop position.
	Drainage pump stop missing.	Check that the coloured stop on the right in the bottom drain is in place. See the chapter <i>Care and cleaning</i> .
Spots on stainless steel or silver.	Some foodstuffs, such as mustard, mayonnaise, lemon, vinegar, salt and dressings, can cause spots on stainless steel if left for too long.	Rinse off these types of foodstuffs if not starting the dishwasher immediately. Use the Rinse and hold program.
	All stainless steel can cause spots on silver if they come into contact during dishwashing. Aluminium can also cause spots on dishes.	In order to avoid marks and tarnishing, separate dishes made from different metals, such as silver, stainless steel and aluminium.

Troubleshooting

Problem	Possible causes	Action
Spots or films on the dishes.	Incorrect rinse aid dosage setting.	See the chapter <i>Settings</i> .
	The setting TAB is activated and all-in-one detergent with insufficient drying effect is being used.	Switch all-in-one detergents or deactivate the setting TAB and top up with salt and separate rinse aid. See Rinse aid in the chapter <i>Settings</i> .
	Salt compartment empty.	Top up with salt. See the chapter <i>Care and cleaning</i> .
	Incorrect water softener setting.	See Water hardness in the chapter <i>Settings</i> .
	The water softener is leaking salt.	Check that the salt compartment lid is properly tightened. Otherwise call the service department.
	Too high temperature and/or too much detergent can cause etching on crystal. Unfortunately, this cannot be repaired, only prevented.	Wash crystal at a low temperature and with a conservative amount of detergent. Contact the detergent manufacturer.
The dishes have a sticky white/blue film.	Rinse aid dosage setting too high.	Reduce the dosage. See the chapter <i>Settings</i> . If you have very soft water, you may want to dilute the rinse aid 50:50 with water.
Spots left after washing.	Lipstick and tea can be difficult to wash off.	Use a detergent with a bleaching agent.
Detergent residue in the detergent compartment after dishwashing.	The detergent compartment was damp when adding detergent.	The detergent compartment must be dry when adding detergent.
	The detergent compartment has been blocked.	Check that the dishes are not preventing the detergent compartment from opening.
Rattling sound when dishwashing.	The dishes are not correctly placed or the spray arms are not rotating.	Check that the dishes are placed securely. Spin the spray arms to make sure they can rotate.
1 minute appears in the display.	The program is taking longer than estimated.	No action. The program time is stored and next time the program is run the corrected time will be displayed.

Problem	Possible causes	Action
Water remains in the dishwasher.	The filters are clogged.	Clean the coarse and fine filters.
	The filters are not fitted correctly.	Check that the filter handle is locked in the stop position.
	Debris in the drainage pump.	Clean the drainage pump. See the chapter <i>Care and cleaning</i> .
	Drainage pump stop missing.	Check that the coloured stop on the right in the bottom drain is in place. See the chapter <i>Care and cleaning</i> .
	Kink in drainage hose.	Check that the hose is free from kinks and sharp bends.
	Blocked drainage hose.	Disconnect the drainage hose where it connects to the sink unit's water trap. Check that no debris has fastened and that the connection has an inner diameter of at least 14 mm.
Bad odour in dishwasher.	Dirt around the seals and in corners.	Clean with washing-up brush and low foaming cleaner.
	Low temperature programs have been selected for a prolonged period.	Run a program with a high temperature once or twice a month. Or run a self-cleaning program. See Self-cleaning in the chapter <i>Using the dishwasher</i> .
Grease deposits in the dishwasher.	Low temperature programs have been selected for a prolonged period.	Or run a self-cleaning program once or twice a month. See Self-cleaning in the chapter <i>Using the dishwasher</i> . Select a program with a high temperature to dissolve grease on very dirty dishes, such as Intensive. Or run a self-cleaning program once or twice a month. See Self-cleaning in the chapter <i>Using the dishwasher</i> .

Troubleshooting

Problem	Possible causes	Action
The dishes are not dry enough.	The dishwasher is not fully loaded.	Fully load the dishwasher.
	Rinse aid needs topping up or dosage is set too low.	Top up with rinse aid or increase the rinse aid dosage level. See the chapter <i>Settings</i> .
	The setting TAB is activated and all-in-one detergent with insufficient drying effect is being used.	Switch all-in-one detergents or deactivate the setting TAB and top up with salt and separate rinse aid. See Rinse aid in the chapter <i>Settings</i> .
		Open the door a little once the program has finished.

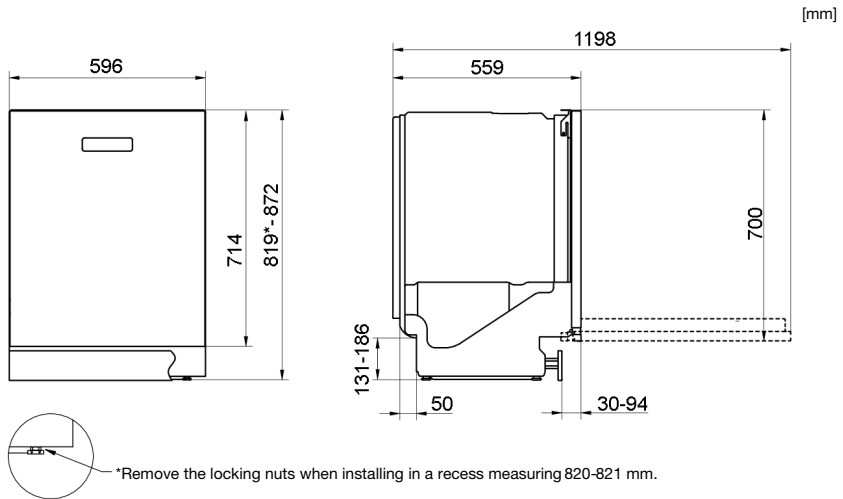

Nominal dimensions. Actual measurements may vary.

Safety instructions

- Connections to electricity, water and drainage must be performed by a qualified professional.
- Always follow applicable regulations for water, drainage and electricity.
- Take care during installation! Wear protective gloves! There must always be two people!
- Place a drip tray on the floor beneath the dishwasher to prevent damage from any water leaks.
- Before screwing the dishwasher into place, test the dishwasher by running the Rinse and hold program. Check that the dishwasher fills with water and drains. Check also that none of the connections leak.

WARNING!

Turn off the water supply when installing the dishwasher!

The plug must be disconnected or power to the socket turned off while the work is carried out!

Installation

Transport protection for the door

Do not forget to remove the transport protection for the door when unpacking the dishwasher.

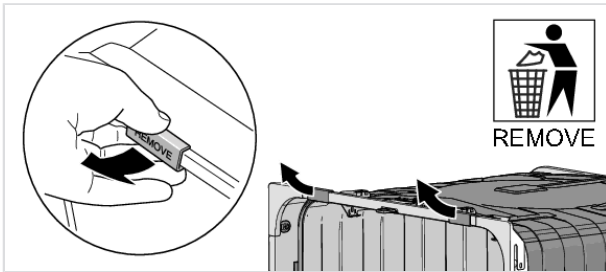

Placing the dishwasher

The dishwasher can be installed built-in, completely freestanding or partially built-in. Make sure the area on which the dishwasher is to be installed is firm.

A. Built-in

The dishwasher is intended for installation under a worktop. The recess dimensions are illustrated. Holes for wires/cables need not be larger than 38 mm in diameter. Make sure the edges of such holes are even to prevent damage to the drainage and inlet hoses and the power cable.

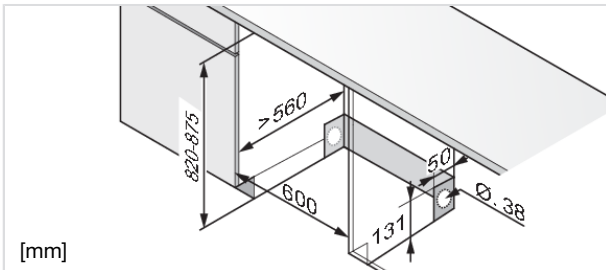

If the dishwasher is built-in the surrounding furnishings must be resistant to any condensation from the dishwasher.

B. Freestanding

A freestanding dishwasher must be fitted with anti-tip brackets. This comprises two brackets, which are screwed into place as illustrated.

The dishwasher is then pushed in so that the brackets engage the rear feet. Now the dishwasher will not topple if pressure is put on the open door. If the dishwasher is installed completely on its own, side panels and a worktop must both be fitted. Accessories can be purchased where you bought the dishwasher.

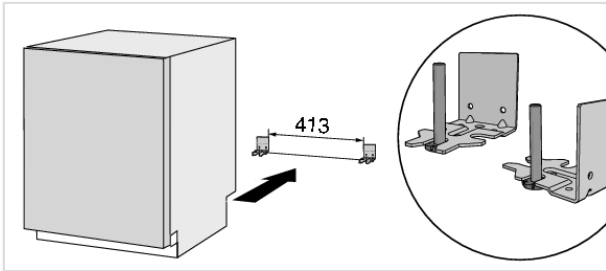

⚠ WARNING!

A completely freestanding dishwasher must be fitted with anti-tip brackets.

C. Partially built-in

If the dishwasher is located so that one of its sides is visible, a side panel must be fitted. Accessories can be purchased where you bought the dishwasher.

Affix the protective film

Affix the protective film (packed in the document bag). The protective film is to protect the worktop from moisture.

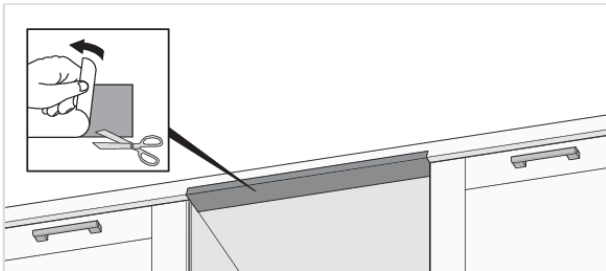

NOTE!

The surface to which the protective film is affixed must be clean and dry.

Adjust the height and slide the dishwasher into place

1. Start by measuring the height from the floor to the bottom edge of the worktop.
2. Measure the height from the floor to the top edge of the dishwasher.
3. Lean the dishwasher forwards a little and adjust the rear foot with the screw at the front of the dishwasher. Turn clockwise to lower or anticlockwise to raise.

Installation

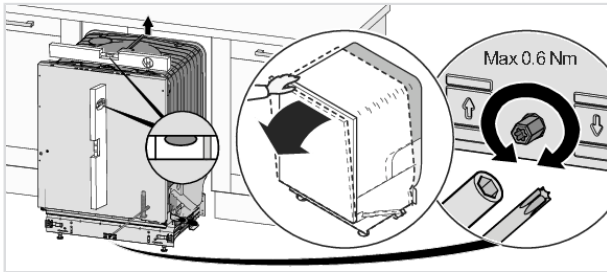

4. Adjust the front feet by turning them clockwise to raise and anticlockwise to lower the dishwasher.

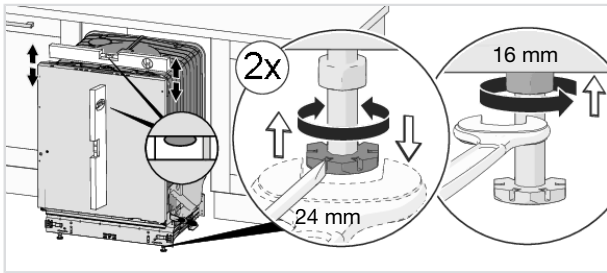

5. Check that there is an air gap of at least 3 mm between the underside of the worktop and the top edge of the dishwasher.
6. Slide the dishwasher into place.
- Pull the supply and drainage hoses when sliding the dishwasher into place.
 - Check that the hoses have no kinks or sharp bends, and check that there is nothing that can damage the hoses.

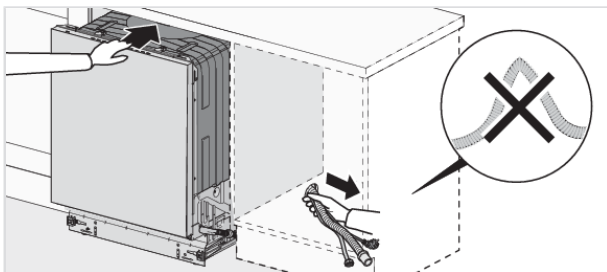

7. Make any final adjustments to the feet (the dishwasher may lean no more than 5 mm) and tighten the lock nuts on the front feet.

Drainage connection

This dishwasher is suitable for installing in a raised recess (to attain an ergonomic working height). This means that the dishwasher can be placed so that the drainage hose runs to a lower level than the bottom of the dishwasher, such as by routing it directly to a floor drain. The dishwasher is fitted with an integrated anti-siphon device to prevent the machine from being emptied of water during the wash cycle.

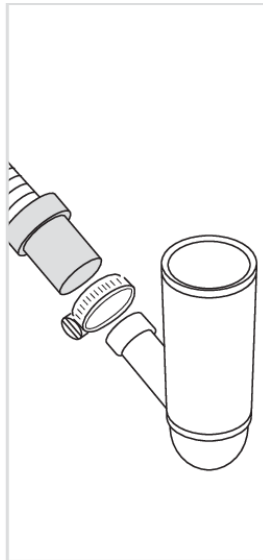
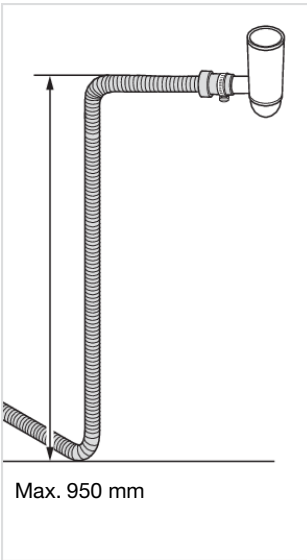
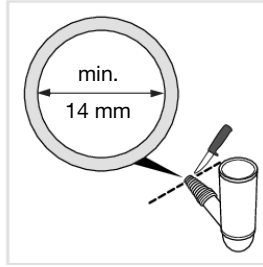
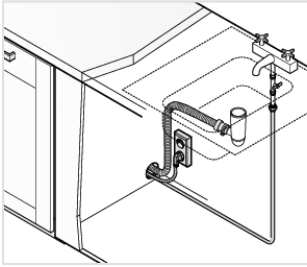

The drainage hose can also be connected to a connection nipple on the sink unit's water trap. The connection nipple must have an internal diameter of at least 14 mm.

The drainage hose may be extended by a maximum of 2.5 m (the total length of the drainage hose must not exceed 4.5 m). Any joints and connecting pipes must have an internal diameter of at least 14 mm. However, the drainage hose should ideally be replaced with a new hose without joints.

No part of the drainage hose may be more than 950 mm above the bottom of the dishwasher.

Attach the drainage hose with a hose clamp. Ensure that the drainage hose has no kinks.

Connection to water supply

Use only the inlet hose supplied with the dishwasher. Do not re-use old or other spare hoses.

The supply pipe must be fitted with a water tap (stopcock). The water tap must be easily accessible, so that the water can be shut off if the dishwasher has to be moved.

Once the installation is complete, turn on the water tap and allow the pressure to settle for a while. Check that all connections are watertight.

Installation

Connection to cold water supply

Connect the dishwasher to the cold water supply if the building is heated using oil, electricity or gas.

Connection to hot water supply

Connect the dishwasher to the hot water supply (max. 70 °C) if the building is heated using an energy-efficient means such as district heating, solar power or geothermal power. Choosing a hot water connection cuts dishwashing times and reduces the dishwasher's energy consumption.

NOTE!

Do not exceed the permitted water supply temperature. Certain materials used in some cookware cannot withstand strong heat. See *Fragile dishes* in the chapter *Loading the dishwasher*.

Electrical connection

Information about the electrical connection can be found on the serial number plate. This specification must match the electricity supply.

The dishwasher must be connected to an earthed socket.

The electric wall socket must be placed outside of the installation area to be easily accessible after installing the dishwasher. Do not use an extension cord!

The dishwasher must be connected to residual current devices as per the relevant safety regulations.

NOTE!

Any repair and maintenance pertaining to safety or performance should be done by trained experts.

Screwing the dishwasher into place (Applicable only to built-in dishwashers.)

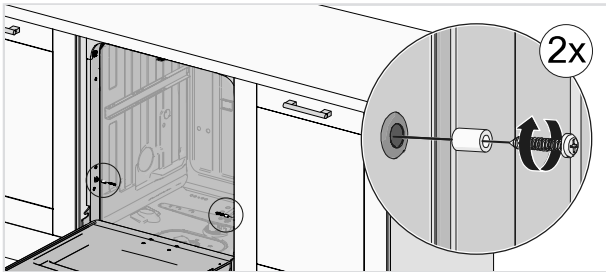
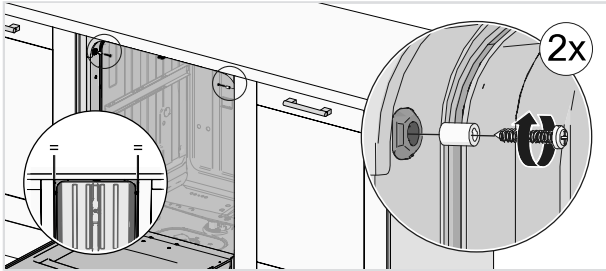

After fastening the machine, check that the front feet still touch the floor.

Installation

Dishwasher toe kick

The dishwasher is supplied with a toe kick.

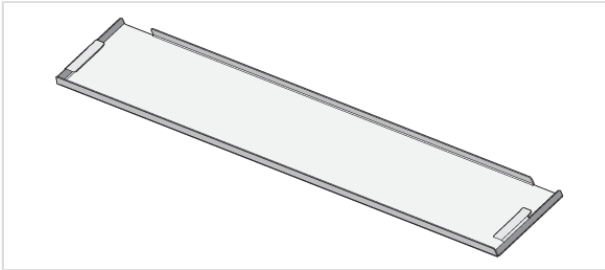

Fit the sound insulation

(only certain models)

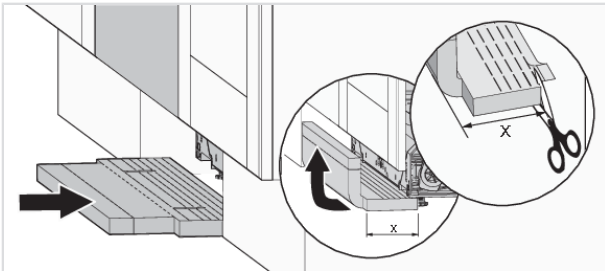

Fit the toe kick

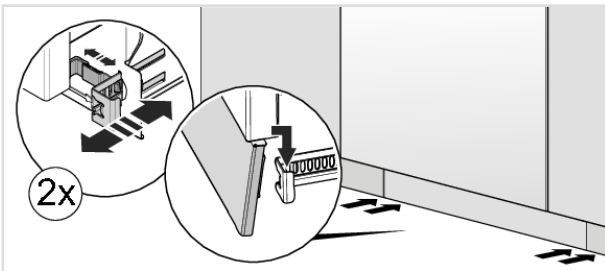

Information about your product

There is a QR code on the serial number plate. Scan the code to view information about your product.

(only certain models)

Contact the service department

Read the chapter *Troubleshooting* before contacting the service centre. If you have encountered a problem that you cannot resolve, please contact your nearest service centre for professional help, see www.asko.com. Our website also has information about spare part availability and what you can repair yourself.

When making contact, provide the details on the serial number plate. Include the article number (1) and the serial number (2).

Please note that non-professional repairs may risk user safety and affect the warranty.

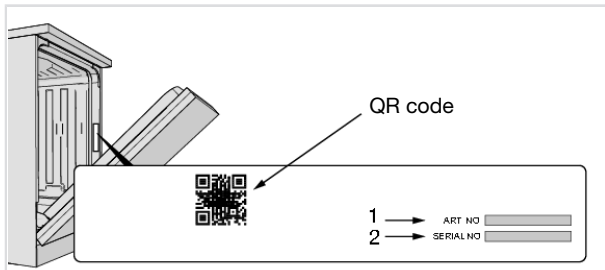

Technical data and energy labelling

Technical data

Height:	819-872 mm
Width:	596 mm
Depth:	559 mm
Weight:	50 kg ¹⁾
Number of standard place settings:	13 ²⁾
Water pressure:	0.03-1.0 MPa
Electrical connection:	See the serial number plate
Rated power:	See the serial number plate

¹⁾ Weight can vary due to different specifications.

²⁾ In accordance with the EN 50242 / EN 60436 standard.

Information for consumers

Information about your product can be found at www.asko.com/energylabel, where you will also find a link to the European Product Database for Energy Labelling, EPREL. Or else visit <https://eprel.ec.europa.eu> directly. Follow the instructions to search by model name.

See the information on the serial number plate. Make a note of the model name (3).

Information for test institute

Information about this product can be found in the European Product Database for Energy Labelling, EPREL, and can also be ordered by e-mail dishwashers@appliance-development.com.

The request should include the details on the serial number plate. Include the article number (1), the serial number (2) and the model name (3).

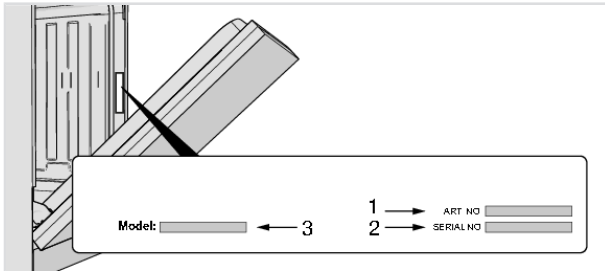

ASKO

Inspired by Scandinavia

ASKO APPLIANCES AB • SOCKERBRUKSGATAN 3, SE-531 40 LIDKÖPING, SWEDEN • WWW.ASKO.COM



809212-a10



We reserve the right to make changes.