



Instructions for use

OVEN

OCS8664A / BO6SA2S3-42
OCS8664B / BO6SA2S3-42
OCS8664S / BO6SA2S3-42
OCS8664A1 / BO6SA2S3-42
OCS8464A / BO4CS2S3-42
OCS8464B / BO4CS2S3-42
OCS8464S / BO4CS2S3-42
OCS8464A1 / BO4CS2S3-42

Pictograms used



Important information



Tip

CONTENTS

Your oven

Introduction	4
Description of the appliance	5
Guide rails/Telescopic guide rails	5
Accessories	6
Door	7
Cooling fan	7
Control panel	8
Control panel general use	9

First use

Before first use	11
Explanation of the knobs and the keys	13

Use

Description of the main functions	15
Description of the sub functions	16
Plus menu	21
Steam function	22

Operation

Using the appliance cooking functions	24
Culisensor (<i>when available</i>)	25

Settings

Settings menu	26
---------------	----

Maintenance

Cleaning the appliance	27
Cleaning function (Steam clean)	27
Cleaning the Water Tank Filter	28
Descaling	28
Removing and cleaning the guide rails	29
Replacing the oven lamp	29
Removal and installation of the oven door	30

Malfunctions

General	32
---------	----

Environmental aspects

Disposal of the appliance and packaging	34
---	----

Introduction

Congratulations on choosing this oven. This product is designed with simple operation and optimum comfort in mind.

This manual shows how you can best use this oven. In addition to information about operating the appliance, you will also find background information that may be useful when using the appliance.



Please read the separate safety instructions carefully before using the appliance!

Read this manual before using the appliance and keep it in a safe place for future use.

Installation instructions are supplied separately.

YOUR OVEN

Description of the appliance

1. Control panel
2. Water reservoir cover
Push to open!
3. Oven levels
4. Oven door
5. Door handle

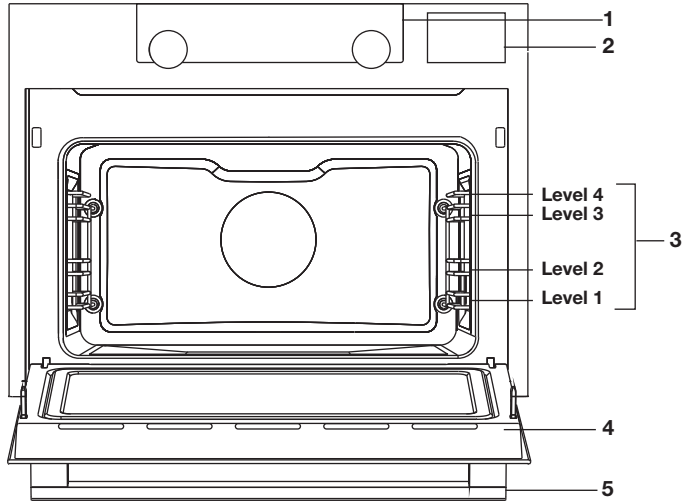

Guide rails/Telescopic guide rails

- The oven has four or five guide rails (Level 1 to 4/5), depending on the model. Level 1 is mainly used in combination with bottom heat. The two upper levels are mainly used for the grill function.
- Place the oven rack, baking tray or steam dish in the gap between the guide rail sliders.
- A number of shelf levels can have fully-retractable telescopic guide rails, depending on the model.
 - ▷ Pull the telescopic guide rails out of the oven cavity completely and place the oven rack / baking tray / steam dish on them. Then slide the oven rack / baking tray / steam dish on the telescopic guide rails, back into the oven cavity.
 - ▷ Only close the oven door when the telescopic guide rails have been returned completely back into the oven cavity.



YOUR OVEN

Accessories

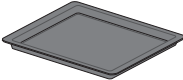

Your appliance is accompanied by a range of accessories, depending on the model. Only use original accessories; they are specially suited to your appliance. Be sure that all the accessories that are being used are able to withstand the temperature settings of the chosen oven function.

Note: not all accessories are suitable/available for every appliance (it may also differ by country). When purchasing, always provide the exact identification number of your appliance. Please see the sales brochures or check online for more details about optional accessories.

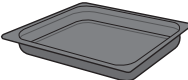
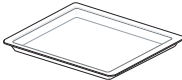
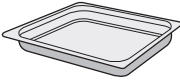
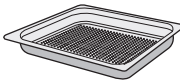
Note: never place an accessory on the bottom of the oven!

Accessories that can be supplied with your appliance (depending on the model)	
	Enamelled baking tray; to be used for pastries and cakes. <ul style="list-style-type: none">• Do not use the enamelled baking tray for microwave functions!• Suitable for pyrolysis cleaning.
	Oven rack; mainly used for grilling. A steam dish or pan with food can also be placed on the oven rack. <ul style="list-style-type: none">• The oven rack is equipped with a safety peg. Lift the rack slightly at the front to slide it out of the oven.• Do not use the oven rack for microwave functions!
	Deep enamelled baking tray; to be used for roasting meat and baking moist pastry. <ul style="list-style-type: none">• Do not place the deep baking tray on the lowest level during a cooking process, except when using it as a drip tray during grilling, roasting or roasting with a spit roast (when available).• Do not use the deep enamelled baking tray for microwave functions!• Suitable for pyrolysis cleaning.
	Glass baking tray; for microwave and oven use. <ul style="list-style-type: none">• NOT suitable for pyrolysis cleaning.
	Non-perforated steam dish; 40 mm deep (useful for collecting moisture during steaming). <ul style="list-style-type: none">• Note: discolouration may occur at temperatures above 180 °C! This will not influence the proper function of the oven.
	Perforated steam dish; 40 mm deep (useful for steam settings). <ul style="list-style-type: none">• Note: discolouration may occur at temperatures above 180 °C! This will not influence the proper function of the oven.

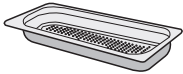
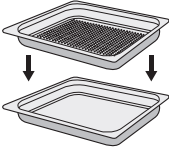
YOUR OVEN

Accessories that can be supplied with your appliance (depending on the model)	
	<p>Perforated steam dish; 1/3GN. Perforated steam dish; 1/2GN.</p> <ul style="list-style-type: none">• Note: discolouration may occur at temperatures above 180 °C! This will not influence the proper function of the oven.
	<ul style="list-style-type: none">• The steam dishes can be used simultaneously on two levels. Place the perforated steam dish in the middle of the oven and the non perforated steam dish one level below the perforated steam dish.• For steaming you can place the perforated steam dish in the non-perforated steam dish. They can only be used together on a level with telescopic guide rails.
	<p>Culisensor; can be used to measure the core temperature of the dish. When the desired temperature is reached, the cooking process will be stopped automatically.</p>

Door

- The door switches interrupt the operation of the oven when the door is opened during use. The oven continues operating when the door is closed.

Cooling fan

- The appliance is equipped with a cooling fan that cools the casing and control panel.

YOUR OVEN

Control panel

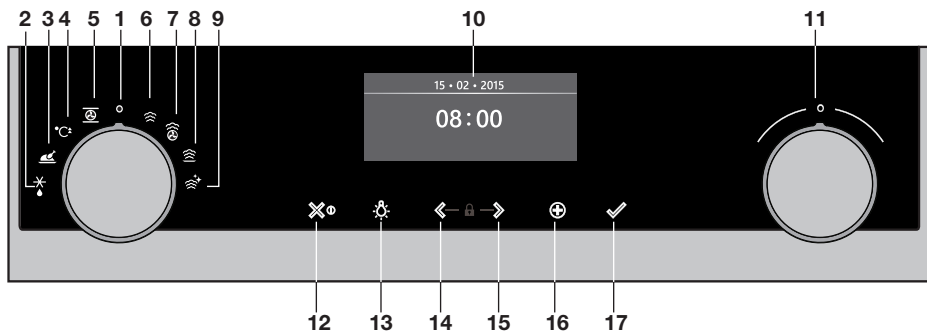

1. Function knob (in 'Off' position)
2. Defrost
3. Automatic programs
4. Fast preheat
5. Oven
6. Steam
7. Combi steam
8. Warming
9. Cleaning
10. Display
11. Selection knob
12. On/off key and stop key (cancel)
13. Light key
14. Navigation key left
15. Navigation key right
16. Plus key
17. Confirm key



The keys respond best if you touch them shortly with a large area of your fingertip. Every time you touch a key during use, a short acoustic signal will sound.

Control panel general use

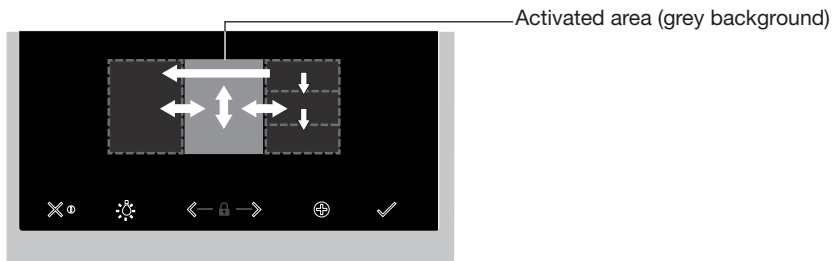

Set a function and settings

1. Touch and hold the on/off key to switch on the appliance.
 2. Turn the function knob to set a main oven function.
The main oven functions are visible around the oven function knob and in the display. The function icon is displayed larger. The 'active area' (recognizable by a grey background) moves to the right.
 3. Turn the selection knob to select a sub oven function.
The 'active area' shows the several different sub oven functions. Scroll up or down to view the different functions. If a chosen main function does not have a sub function then the next available setting appears in the active area.
 4. Touch the selection knob (or the right navigation key) to confirm the chosen sub oven function or setting.
The 'active area' (grey background) moves to the right.
 5. Turn the selection knob to change the next available settings (left = decrease, right = increase) and confirm by touching the selection knob or touching the right navigation key.
- When all elements in the screen are set, then confirm these settings by touching the confirm key.
 - When the confirm key is blinking it is possible to start the oven with the default settings.
 - Touch the left navigation key to move the active area to the left to change an already made setting. Change the setting by turning and touching the selection knob.
 - Touch the stop key to go one-step back in the menu.

Follow the instructions on the display.

YOUR OVEN

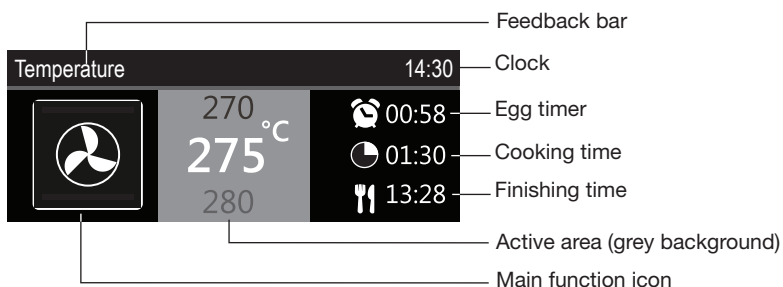

- The display will show the icon and name of the activated function for about 1.5 seconds.
- The feedback bar shows what setting you are changing. .

Delayed start

- Set an desired cooking time and finishing time to start cooking at a later time.

Display

When the appliance is in progress you see the following information in the display:

- Active oven (sub) function
- Temperature
- Egg time (when set / See 'Plus menu')
- Cooking time (cooking time counting up or counting down when cooking time has been set)
- Finishing time (when cooking time has been set)

Stand-by mode

The stand-by display will show the time, date and the timer (if set). The appliance goes to stand-by mode after turning the function knob to 0 ('off' position).

Switching on the appliance

- Touch and hold the on/off key to switch on the appliance.
- The appliance can also be switched on by turning the function knob to a function.

Shutting down the appliance

- Touch and hold the stop key to shut down the appliance manually.
- Default the appliance will shut down when there has been no action during 30 minutes.

FIRST USE

Before first use

- Clean the appliance interior and accessories with hot water and washing-up liquid. Do not use aggressive cleaning agents, abrasive sponges and similar.
- The appliance will emit a particular odor when it is used for the first time; this is normal. Make sure that there is good ventilation during initial use.



When the appliance is first plugged in or after connection when the appliance was disconnected from the power mains for a long period of time, you have to set 'Language', 'Date' and 'Time'.

Setting the language

Language	12:00
English	
Français	
Nederlands	

In case you are not comfortable with the language on the display, you can select another language. The default setting is 'English'.

1. Turn the selection knob and select your preferred language from the displayed list.
2. Confirm the setting by touching the confirm key.

The next screen will be displayed.

Setting the date and time

Year	12:00		Hours	12:00	
2017	01	01	11	30	
2018			12		
			13		

1. Turn the selection knob and change the first setting (Year).
2. Confirm this setting by touching the right navigation key or by touching the selection knob.
3. Turn the selection knob and change the next setting (Month).
4. Confirm this setting by touching the right navigation key or by touching the selection knob.
5. Turn the selection knob and change the last setting (Day).
6. Confirm this setting by touching the confirm key.

The next screen will be displayed. Now set the hours and minutes with the selection knob and navigation key. Confirm your setting by touching the confirm key.

FIRST USE

All the start-up settings are now set and the display will show the stand-by screen. The appliance is now ready for use.



The language, time and date can be adjusted in the settings menu (see 'Settings menu' chapter). The settings menu can be opened from the start display via the 'Plus' menu.

Setting the water hardness

The water hardness must be set prior to initial use. If the water is softer or harder than the default setting, you can alter the set hardness level.

Checking the water hardness

- You can measure water hardness using the 'paper test strip' supplied with your appliance. For information about water hardness in your region please contact your local water board.

Using the 'paper test strip'

- Dip the test strip in water for 1 second. Wait 1 minute and read the number of bars on the paper strip. Check the table for the correct water hardness setting.

Setting the water hardness

- Compare the test strip with the image on the display.
- Turn the selection knob until the bars on the screen correspond with those on the test strip.
- Touch the confirm key to save the set water hardness.

Water hardness table

Display	Test strip number/colour of the bars	Type	PPM	French hardness (°df)	German hardness (°dH)
1	4 green bars	Very soft water	0 - 90	0 - 9	0 - 5
2	1 red bar	Soft water	90 - 178	9 - 18	5 - 10
3	2 red bars	Rather hard water	178 - 267	18 - 26	10 - 15
4	3 red bars	Hard water	267 - 356	26 - 35	15 - 20
5	4 red bars	Very hard water	> 356	> 35	> 20

The appliance has now been programmed so that the descaling notification will appear in accordance with the actual water hardness.

Explanation of the knobs and the keys

Function knob



Select a function

Turn this knob to select the desired function.

- See 'Description of the functions' for more information.

Selection knob



To choose a sub oven function

Turn this knob to choose a sub oven function.

- See 'Control panel general use' for more information.



Change the settings

Turn this knob to change the settings that are in the active area.

- See 'Control panel general use' for more information.



Go to the next setting

Touch this knob to go to the next setting.

- The next to change setting will be in the grey active area.

On/off key and stop key



To switch the appliance on or off

Touch and hold the key for several seconds to switch the appliance on or off.



To cancel or go back in the menu

Touch this key to cancel an operation or to go back one-step in the menu.



Lighting key





Switch the lighting on/off

Touch this key to switch the cavity lighting on or off.

Navigation keys

	<p>Navigate to the right</p> <p>Touch the right navigation key to confirm the setting and to move the active area to the right.</p>
	<p>Navigate to the left</p> <p>Touch the left navigation key to move the active area to the left.</p>
	<p>Turn on/off the child lock function</p> <p>Touch and hold the navigation keys simultaneously to activate/deactivate the child lock function.</p> <ul style="list-style-type: none"> • The oven's control panel can be locked by means of the Child Safety Lock, to protect the oven against unintended use.

Plus key

	<p>To open the settings menu (see 'Settings')</p> <p>Touch this key in stand-by mode to open or exit the settings menu:</p> <ul style="list-style-type: none"> • Egg timer • General • Display • Cooking • System
	<p>To open extra options (see 'Plus menu')</p> <p>Touch this key in operation mode to open or exit the extra options possible at that moment:</p> <ul style="list-style-type: none"> • Egg timer • Fast preheat • Add steam 123 • Add direct steam





Confirm key

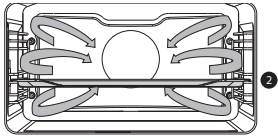

	<p>Confirm key</p> <p>To confirm all the white settings/elements in the screen.</p>
---	--

Description of the main functions

Consult the tables to select the preferred function. Also consult the instructions for preparation on the dish packaging. Some main functions have sub functions.

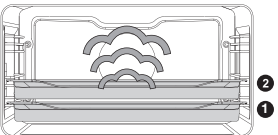
Main functions (to select with the function knob)

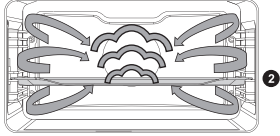





Function	Description	
	<p>Oven</p> <ul style="list-style-type: none"> • Use one of the functions available for grilling, baking or roasting. • Sub functions are available (consult Oven functions table). 	
	<p>Fast preheat</p> <ul style="list-style-type: none"> • With this function, the oven space quickly reaches the desired temperature. Do not use this setting when you have a dish in the oven space. 	
	<p>Programs</p> <ul style="list-style-type: none"> • Use 'Programs' for baking and roasting by selecting a dish from a list of pre-programmed dishes. 	
	<p>Defrost</p> <ul style="list-style-type: none"> • With this function, the air circulates by means of the fan. The air will be heated to a temperature of 30 °C. Dishes are defrosted quickly and efficiently. 	
	<p>Steam</p> <ul style="list-style-type: none"> • Heating by means of steam. • See chapter 'Steam function' for more information. • Steam of 100 °C is sprayed into the oven cavity at regular intervals. • Sub functions are available (consult steam functions table). 	

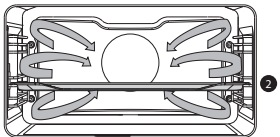

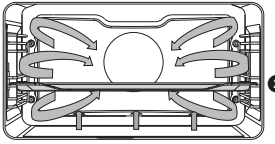

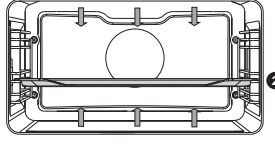

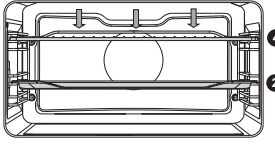
Function	Description	
	<p>Combi steam</p> <ul style="list-style-type: none"> • Heating by means of hot air in combination with steam. • The steam is sprayed into the oven cavity at regular intervals. • This mode can be used for baking types of pastry such as puff pastry, brioche pastry, yeast dough buns, French bread, gratins and roasting meat. The hot steam ensures a nice crispy brown top and an airy texture. Meat and fish remain nice and juicy inside. For this mode always make sure that the water reservoir is filled with fresh water. • Sub functions are available (consult combi-steam functions table). 	
	<p>Regenerate</p> <ul style="list-style-type: none"> • Use one of the functions for (keep) warm dishes. • Sub functions are available (consult Warming functions table). 	
	<p>Cleaning</p> <ul style="list-style-type: none"> • With this function and a damp cloth, you can easily remove grease and dirt from the oven walls. • Use this function only when the oven has cooled down fully. Steam is sprayed into the oven cavity at regular intervals. • After soaking, food residues can be removed using a damp cloth. 	

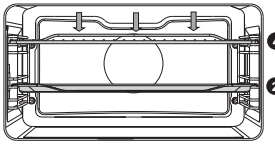
Description of the sub functions

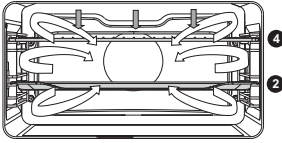

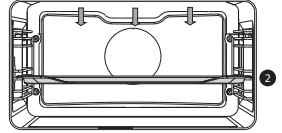
Oven functions (to select with the selection knob)

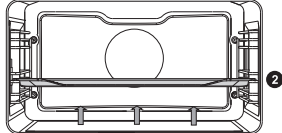
	<p>Hot Air</p> <ul style="list-style-type: none"> • Heating by means of hot air from the back of the oven. • This mode provides uniform heating and is ideal for baking. • Place the baking tray or oven rack on the middle of the oven. • Suggested temperature: 180 °C • Preheating is recommended. 	
---	---	--

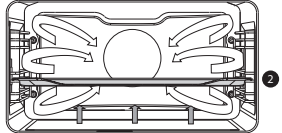

	<p>Hot Air + Bottom Heat</p> <ul style="list-style-type: none"> • Heating by means of hot air from the back of the oven and the bottom heating element. • This mode can be used to bake pizza, moist pastry, fruitcakes, leavened dough and short crust. • Place the baking tray or oven rack in the middle of the oven. • Suggested temperature: 200 °C • Preheating is recommended. 	
	<p>Top Heat + Bottom Heat</p> <ul style="list-style-type: none"> • Heating by means of the upper and lower heating elements. • This mode can be used for traditional baking and roasting. • Place the baking tray or oven rack in the middle of the oven. • Suggested temperature: 200 °C • Preheating is recommended. 	
	<p>Large Grill</p> <ul style="list-style-type: none"> • Heating by means of the upper element and grill element. • This mode can be used with dishes and baked goods that require a distinctive bottom crust or browning. Use just before the end of the baking or roasting time. • Place the oven rack in the upper part of the oven and the baking tray in the middle of the oven. • Monitor the cooking process at all times. The dish may burn quickly due to the high temperature. • Preheating is recommended. 	
	<p>Grill</p> <ul style="list-style-type: none"> • Heating by means of the grill element. • This mode can be used for grilling a smaller amount of open sandwiches, beer sausages, and for toasting bread. • Place the oven rack in the upper part of the oven and the baking tray in the middle of the oven. • Monitor the cooking process at all times. The dish may burn quickly due to the high temperature. • Preheating is recommended. 	

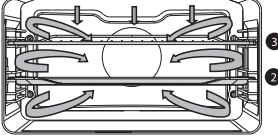
	<p>Large grill + Fan</p> <ul style="list-style-type: none"> • Heating by means of the top heating elements. The heat is distributed by the fan. • This mode can be used for grilling meat, fish and vegetables. • Place the oven rack in the upper part of the oven and the baking tray in the middle of the oven. • Suggested temperature: 170 °C • Monitor the cooking process at all times. The dish may burn quickly due to the high temperature. • Preheating is recommended. 	
	<p>Top Heat</p> <ul style="list-style-type: none"> • Heating only by means of the upper heating element. • This mode can be used when you wish to bake/roast the top part of your dish. • Place the baking tray or oven rack in the middle of the oven. • Suggested temperature: 150 °C 	
	<p>Bottom Heat</p> <ul style="list-style-type: none"> • Heating only by means of the lower heating element. • This mode can be used with dishes and baked goods that require a distinctive bottom crust or browning. • Use just before the end of the baking or roasting time. • Place the baking tray or oven rack in the lower part of the oven. • Suggested temperature: 160 °C 	
	<p>Fan + Bottom Heat</p> <ul style="list-style-type: none"> • Heating by means of the lower heating element. The heat is distributed by the fan. • This mode can be used for baking low leavened cakes, as well as for preservation of fruit and vegetables. • Place a not too high baking tray in the lower part of the oven, so that hot air can also circulate over the upper surface of the food. • Suggested temperature: 180 °C 	

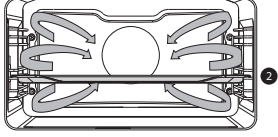
USE

	<p>Pro Roasting</p> <ul style="list-style-type: none"> • Heating by means of the upper heating element in combination with the grill heating element and hot air. • This mode can be used for roasting all types of meat. • Suggested temperature: 180 °C 	
	<p>ECO Hot air</p> <ul style="list-style-type: none"> • Heating by means of hot air. ECO hot air uses less energy but gives the same result as the hot air setting. Cooking takes a few minutes longer. • This mode can be used for roasting meat and baking pastry. • Place the baking tray or oven rack in the middle of the oven. • Suggested temperature: 180 °C • This setting makes use of the residual heat (heating is not on the whole time) to achieve low energy consumption (in accordance with energy class EN 60350-1). In this mode the actual temperature in the oven is not displayed. 	

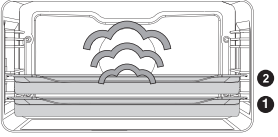
Steam functions table (to select with the selection knob)

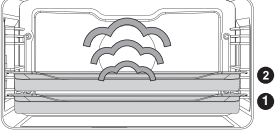
	<p>Steam</p> <ul style="list-style-type: none"> • Heating by means of steam. • See chapter 'Steam function' for more information. • Steam of 100 °C is sprayed into the oven cavity at regular intervals. • This mode can be used to steam vegetables, eggs, fruit and rice, for example. 	
	<p>Steam - Low temperature</p> <ul style="list-style-type: none"> • Heating by means of steam. • See chapter 'Steam function' for more information. • Steam is sprayed into the oven cavity at regular intervals. • This menu can be used to steam vegetables and fish, to keep food warm and defrost food. 	

	<p>Sous vide</p> <ul style="list-style-type: none"> • Heating by means of steam. • See chapter 'Steam function' for more information. • The vacuum-sealed food is slow-cooked at a low temperature. • With this method the food's flavour, vitamins and minerals are preserved. Vacuum sealing gives the dish a longer shelf life. • Use this function to cook vegetables, fruit, meat, poultry and fish. 	
--	---	--

Combi-steam functions table (to select with the selection knob)

<p>High 3</p>	<p>Hot air + Steam density 1 / 2 / 3</p> <ul style="list-style-type: none"> • Heating by means of hot air in combination with steam. • The steam is sprayed into the oven cavity at regular intervals. • This mode can be used for baking types of pastry such as puff pastry, brioche pastry, yeast dough buns, French bread, gratins and roasting meat. The hot steam ensures a nice crispy brown top and an airy texture. Meat and fish remain nice and juicy inside. For this mode always make sure that the water reservoir is filled with fresh water. • HIGH: cooking escalopes, steaks and smaller chunks of meat • MEDIUM: reheating cool/frozen meals, cooking fish fillets and vegetables au gratin • LOW: cooking large chunks of meat (roast, whole chicken), baking risen dough (bread and rolls), cooking lasagna etc. 	
<p>Medium 2</p>		
<p>Low 1</p>		

Warming functions table (to select with the selection knob)

	<p>Plate warming</p> <ul style="list-style-type: none"> • This function is used for warming tableware, so that the served food stays hotter for longer. 	
	<p>Keep warm</p> <ul style="list-style-type: none"> • This mode is used to keep already cooked dishes warm. 	
	<p>Regenerate</p> <ul style="list-style-type: none"> • Regenerate: this mode is used to warm already cooked dishes. The use of steam means there is no loss of quality. Taste and texture are preserved as though the dish is freshly-cooked. Various dishes can be regenerated simultaneously. 	

Plus menu

Touch the Plus key to choose extra functionality (after you have chosen a main function and settings).

- Select a function by turning the selection knob and confirm with the confirm key.
- To exit the plus menu, touch the 'stop key' or 'plus key'; the display will show the previous screen again.

Plus Menu	Description
	<p>Egg timer</p> <p>The egg timer can be used independently of the oven function.</p> <ul style="list-style-type: none"> • When the egg timer goes off, a message pop-up will appear and an acoustic signal will sound. • Touch the stop key to switch off the signal and close the pop-up menu. • The sound will stop automatically after approximately two minutes. • To cancel the timer, set the time to 0:00.
	<p>Fast preheat</p> <p>Switch default fast preheat on/off (only available in oven functions).</p>
	<p>Add steam 123</p> <ul style="list-style-type: none"> • Divide up to three steam cycles evenly over the cooking process. • Only available when a cooking time has been set. • Choose at least 10 minutes cooking time.
	<p>Add direct steam</p> <ul style="list-style-type: none"> • Add a steam cycle to the cooking process.
	<p>Cancel steam 123</p> <ul style="list-style-type: none"> • If the function is activated.
	<p>Cancel direct steam</p> <ul style="list-style-type: none"> • If the function is activated.

Starting with fast preheat

- When a program is started and fast preheat is set default 'on' in the settings menu, a pop-up will appear. After 15 seconds the pop-up will automatically disappear. The progress screen will show the fast preheat icon, the time will be greyed out.
- If the set temperature is reached a message will pop-up. Insert the dish and the program will start automatically when the door is closed.

Steam function



Warning – Risk of scalding! Leave the door closed during steam functions, hot steam can escape in case of opening. Condensation in the oven will increase when opening the door.



Note: Let the oven cool down after every steam function and dry the inside of the oven with a soft cloth.

Note: The water system empties each time the steam function is finished. This action is audible and is part of the steam oven's normal operation.

Advantages of steam cooking

- Healthy and natural, steam cooking retains the colour and taste of the dish. No odors are released using this cooking method.
- Steam cooking (stewing, cooking, roasting) starts before the oven cavity temperature reaches 100 °C.
- Slow cooking (stewing, cooking, roasting) is also possible at lower temperatures.
- It is healthy:
 - ▷ vitamins and minerals are preserved as only a small proportion of these dissolve in the hot moisture of the dish.
- It is not necessary to add any form of fat or oil during steam cooking.
- Steam does not distribute smell or taste, enabling meat or fish to be cooked together with vegetables.
- Steam is also suitable for blanching, defrosting and warming or keeping a dish warm.

Sous vide

Using the sous vide steam function:

- Vacuuming
 - ▷ First vacuum the food in plastic using a vacuuming machine. This process removes most of the air from the plastic bag. The bag preserves nutrients and taste during cooking, resulting in food that is juicier, softer and tastier.
- Vacuum cooking
 - ▷ Cook the dish at the correct temperature and the correct time using the oven's Sous Vide steam setting (see 'Recipes and cooking times').
 - ▷ Most dishes can be kept at serving temperature (around 60 °C) for a few hours, which makes mise en place very easy: you simply remove the dish from the oven when you need it.

Filling the water reservoir

- Always fill the reservoir prior to using a steam function.
 - Use clean and cold tap water, bottled water without added minerals or distilled water suitable for consumption.
1. Press the 'water reservoir' cover to access the water reservoir.
 2. Use the handle to remove the reservoir from the oven.
 3. Remove the water reservoir lid and clean the water reservoir with clean water.
 4. Fill the reservoir with water up to the 'MAX' mark on the reservoir (around 1.2 litres).
 5. Push the water reservoir back in the oven until a click is heard (position switch is activated).
 6. Close the water reservoir cover.



Any water remaining in the steam system after cooking will be pumped back into the water reservoir. Empty, clean and dry the water reservoir after using the steam function. Only fill the reservoir just prior to using it!

Using the appliance cooking functions

Consult 'Control panel general use' to get information about the general operation of the appliance.

1. Touch the 'On/off key to switch on the appliance.
2. Turn the function knob to select a main function.
 - Consult 'Description of the functions' to select the appropriate (available) function.
3. Turn the selection knob to select a sub function (*when available*) or to adjust a setting.
 - The first sub-function setting is active (when available).
4. Start directly the selected function (with pre-set values) by touching the confirm key (this key is blinking if it is possible to start the program).

Available functions or settings to adjust:

- the function (sub oven function);
- the oven temperature;
- the cooking time.

The next sub-function or setting becomes active (if available). Go back to a previous selection or setting by touching the left navigation key.



If preferred, select any additional setting (for example 'Fast preheat') using the plus menu. See 'Plus menu' for more information.

5. Touch the confirm key to start preparing your meal with the chosen settings.

At the end of the cooking you can:

- Stop cooking
 - Touch the confirm key.
The finish display will be closed and the stand-by screen will be shown. If there is no action within 10 minutes, the display will switch to stand-by mode.
- Add extra time
 - Touch the right navigation key to select 'Add extra time'.
The time setting becomes active and can be changed directly by rotating the selection knob.
 - Touch the confirm key.
 - *The previous process is activated again.*

OPERATION

Changing settings during the progress

- During progress, touching the navigation keys will show the active area. The selected setting can now be changed. After confirmation with the confirm key the progress screen will be shown with the changed settings.
- After 5 seconds without actions the progress settings are cancelled and the display will return to the progress screen.

Culisensor (when available)

If the culisensor is plugged in, the culisensor screen will be shown and a small culisensor icon will appear next to the time. The oven operates until the food core reaches the set temperature. The core temperature is measured by means of the temperature probe.

1. Remove the rubber cap from the socket (right upper corner of the oven cavity).
2. Put the culisensor plug in the connection and insert the culisensor completely into the food.

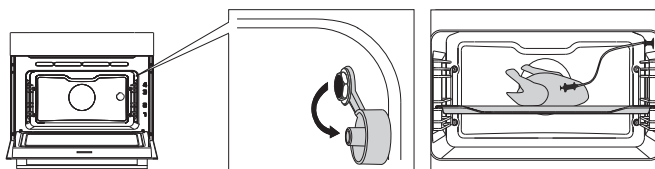

The display will show the culisensor screen and icon.

3. Set the function and temperature. Instead of the time, you need to set the core temperature (between 30 -100 °C).
4. Start the progress by touching the confirm key.
5. During cooking, the rising temperature of the core will be displayed (the desired core temperature may be adjusted during the cooking process).
6. When the set core temperature is reached, the cooking process will stop. An acoustic signal will sound, which you may turn off by touching any key. After one minute, the acoustic signal will be switched off automatically. The current time appears on the display.



Please note!

- Always place the culisensor's entire metal sensor in the dish.
- After the cooking process always replace the metal cap on the culisensor's connection.
- Only use the culisensor in your oven.
- Ensure that the culisensor does not come into contact with the heating element during cooking.
- The culisensor will be extremely hot after the cooking process. **Be careful! Avoid burns.**

SETTINGS

Settings menu

The settings menu is only available by touching the plus key when the appliance is in stand-by mode.

Egg timer (setting an alarm time)
General <ul style="list-style-type: none">• Language of the display• Time<ul style="list-style-type: none">▷ Set time▷ Hour format▷ Clock size• Date<ul style="list-style-type: none">▷ Date yy-mm-dd▷ Date format• Sound<ul style="list-style-type: none">▷ Volume (low-mid-high)▷ Key sound (on / off)▷ Welcome sound (on / off)
Display <ul style="list-style-type: none">• Brightness low, mid, high• Oven light<ul style="list-style-type: none">▷ Auto. switch off after 1 min.▷ Switch off manually• Night mode<ul style="list-style-type: none">▷ Start and end time for lower display brightness:<ul style="list-style-type: none">▷ First display set start timer, second display set end time• Appliance to stand-by<ul style="list-style-type: none">▷ Auto. switch off after 1 hour▷ Always on*
Cooking <ul style="list-style-type: none">• Setting<ul style="list-style-type: none">▷ Descale▷ Water hardness• Preheat settings<ul style="list-style-type: none">▷ Default on / off• Program intensity<ul style="list-style-type: none">▷ Low / medium / high
System <ul style="list-style-type: none">• Appliance information<ul style="list-style-type: none">▷ Appliance name and SW version• Factory settings<ul style="list-style-type: none">▷ Return to factory settings



***Changing to manually switch off will increase energy consumption.**

If the oven is switched off manually (or when an interruption of the power supply occurs) this function will be reset (the display will automatically switch off).

MAINTENANCE

Cleaning the appliance

Clean the oven regularly to prevent fat and food particles from accumulating, especially on the surfaces of the interior and the exterior, the door and the seal.

- Activate the child lock (to prevent that the appliance is switched on accidentally).
- Clean the exterior surfaces with a soft cloth and warm soapy water.
- Next wipe with a clean, damp cloth and dry the surfaces.
- Remove splashes and stains on the interior surfaces with a cloth and soapy water.
- Next wipe with a clean, damp cloth and dry the surfaces.



Important!

Make sure that no water enters the vents. Never use abrasive cleaning materials or chemical solvents. Always make sure that the seal of the door is clean.

This prevents accumulation of dirt and allows you to close the door properly.

Cleaning function (Steam clean)

With Steam clean and a damp cloth, you can easily remove grease and dirt from the oven walls.

Using Steam clean

- Only use Steam clean when the oven has cooled down fully. It is more difficult to remove dirt and grease if the oven is hot.
 - The program takes 30 minutes. Food remains on the enamel walls will be sufficiently soaked after 30 minutes so that they can be removed with a damp cloth.
1. Remove all accessories from the oven.
 2. Select 'Cleaning' with the function knob.
 3. Touch the confirm key to start Steam clean.



Do not open the door during the cleaning program.

MAINTENANCE

Cleaning the Water Tank Filter

If the water tank filter is dirty, you can clean it under the tap.

1. Remove the suction tube with the filter.
2. Clean it out under the tap and put it back into position. Ensure that the filter touches the base of the water tank.

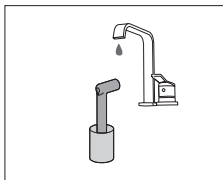
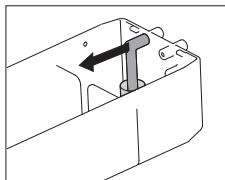

Descaling

During the steam process, there can be an accumulation of mineral deposit in the steam system. This needs to be removed from time to time. You need to carry out this task when the 'Appliance needs descaling' notification is shown. If the appliance is not descaled after three notifications, the steam functions will no longer be available. Use this function only when the oven has cooled down fully. The descaling process comprises descaling and rinsing. Notifications with information and requests for actions will be shown on the display during the process.

1. Pour water mixed with descaling agent into the water reservoir. Consult the descaling agent instructions for the correct mixing ratio.
2. Open the 'Settings' menu and select 'Cooking settings'.
3. Select 'Steamer settings'.
4. Select 'Descaling' to select the function.
5. Touch the confirm key to start descaling.



We advise using NOKALK for descaling. NOKALK is an extremely efficient descaling agent based purely on natural, entirely biodegradable ingredients. The solution is non-corrosive, not aggressive and is environmentally-friendly. As well as an effective descaling action, it also has a cleansing and anti-bacterial effect, ensuring that the appliance's internal components are preserved in an optimum hygienic state. Therefore food's good taste is preserved and the appliance's service life is extended.

- Water is used for the steaming process. Water contains calcium and magnesium. Heat causes the water to condense, leaving a mineral deposit (not harmful to humans).
- If the descaling cycle is interrupted prior to the end of the cycle, the program must be restarted from the beginning.

MAINTENANCE

Removing and cleaning the guide rails

Use conventional cleaning products to clean the guide rails.

1. Remove the screw using a screwdriver.
2. Remove the guide rails from the holes in the back wall.

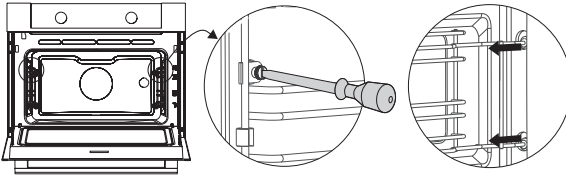

Replacing the oven lamp



The lamp in this household appliance is only suitable for illumination of this appliance. The lamp is not suitable for household room illumination.



The lamp is a consumer item and therefore not covered by warranty. Replace the defective lamp with a lamp of the same type.

Halogen lamp: G9, 230 V, 25 W

The oven is fitted with a halogen lamp.

This product contains a light source of energy efficiency class (G).



Disconnect the appliance from the power supply by removing the plug from the socket or by switching off the circuit breaker in the fuse box.

Please note: the light bulb can be very hot! To prevent burns, use protection to remove the light bulb.

3. Remove the four screws from the cover panel. Remove the cover panel, the glass and the sealing ring.
4. Remove the faulty halogen lamp and replace it with a new one.
5. Replace the cover panel, the glass and the sealing ring.

Attention: The sealing ring needs to fit perfectly in the oven wall recess.

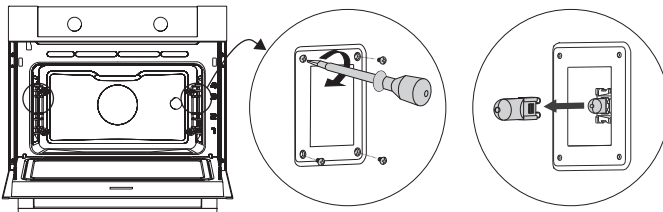

MAINTENANCE

Removal and installation of the oven door

Keep your fingers away from the hinges of the oven door. The hinges are spring loaded and can cause injury if they spring back. Make sure that the hinge latches are applied correctly to lock the hinges.

Remove the oven door

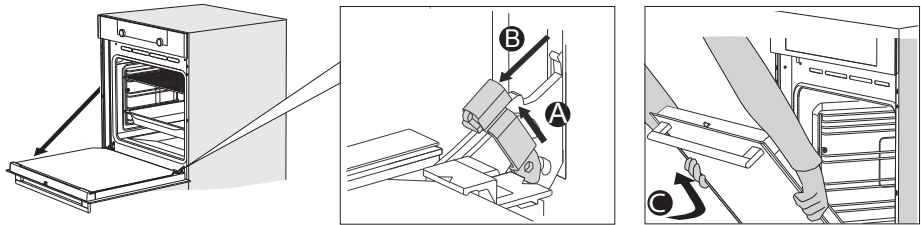

1. Open the door to the fully open position.
2. Lift both hinge latches (A) and pull them towards the oven door (B). The hinges will be locked in the 45° position.
3. Gently close the door until it reaches a 45° angle.
4. Remove the door by lifting and tilting it towards the oven (C). The hinges need to come out of the slots in the oven.

Removal and installation of the oven door glass

Oven door glass may be cleaned from the inside, but you will have to remove the glass from the door.

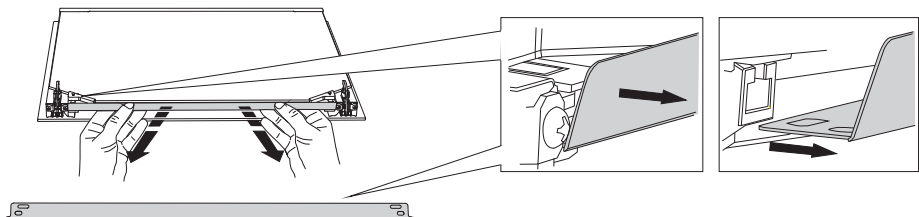

MAINTENANCE

1. Slightly lift (1) and shift (2) the clamps at the lower left and right of the door to release the glass (A).
2. Grab the glass (A) at the bottom and gently lift (3) and shift (4) it to remove it from the upper support.
3. The inner glass (B) (depending on the model) can be removed by carefully lifting (5) and shifting (6) it from the lower support. Also remove the rubber spacers (C) from the inner glass.

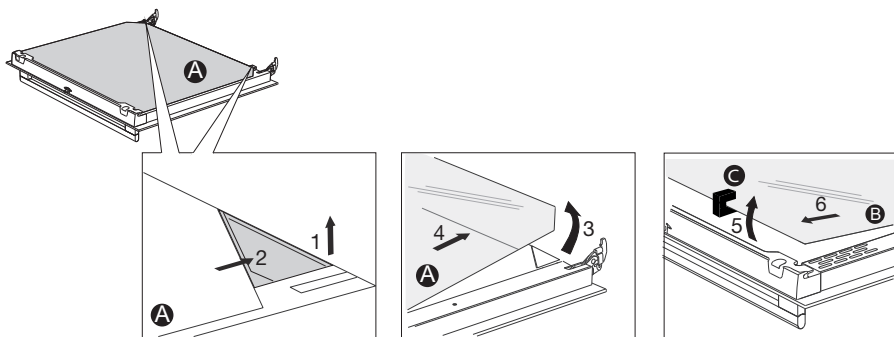

 Install the glass in reverse order.

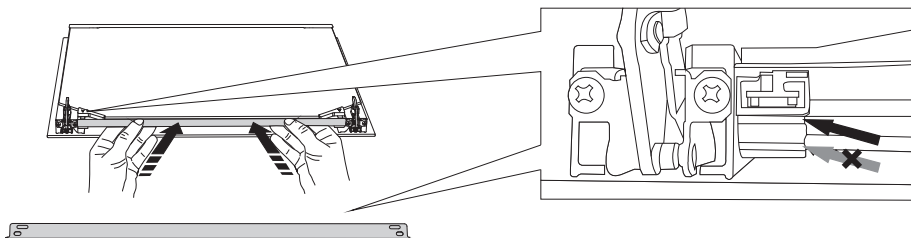

Install the oven door

1. Hold the door at an angle of approximately 45° in front of the oven.
2. Insert the hinges into the slots and make sure they are both positioned correctly.
3. Open the door to the fully open position.
4. Lift both hinge latches and move them towards the oven.
5. Gently close the oven door and make sure that it closes correctly. If the door does not open or close correctly, then make sure that the hinges are positioned correctly in their slots.

MALFUNCTIONS

General

If you have problems with your oven, consult the error overview below. Should the problems persist, please contact the Customer Services Department.

The food stays raw

- Check whether the timer has been set and you have touched the confirm key.
- Is the door closed properly?
- Check whether a fuse has blown and whether a circuit breaker has been activated.

The food is overcooked or undercooked

- Check whether the correct cooking time has been set.
- Check whether the correct power has been set.

The keys do not respond; the display does not respond to the keys.

- Disconnect the appliance from the power supply for a few minutes (remove the mains plug from the socket or switch the circuit breaker to off); then reconnect the appliance and switch it on.

Sparking in the oven space.

- Ensure that all cover panels from the lamps are secure and that all spacers are placed on the guide rails.

Power failure can cause the display to reset.

- Remove the plug from the socket and put it back in again.
- Set the time again.

There is condensation in the oven.

- This is normal. Wipe the oven clean after use.

The fan keeps working after the oven is switched off.

- This is normal. The fan will keep working for a while after the oven is switched off.

Air flow can be felt at the door and the exterior of the appliance.

- This is normal.

Light reflects on the door and the exterior of the appliance.

- This is normal.

Steam escapes from the door or the vents.

- This is normal.

MALFUNCTIONS

Clicking sounds can be heard when the oven is working, particularly in the defrost setting.

- This is normal.

The circuit breaker switches off regularly.

- Consult a service technician.

The display gives an error code, ERROR XX ...

(XX indicates the number of the error).

- There is a fault in the electronic module. Disconnect the appliance from the power supply for a few minutes. Then reconnect it and set the current time.
- Consult a service technician if the error persists.

Storing and repairing the oven

- Repairs should only be performed by a qualified service technician.
If maintenance is required, take the plug from the socket and contact the ASKO customer service.

Have the following information to hand when you call:

- The model number and serial number (stated on the inside of the oven door)
- Guarantee details
- A clear description of the problem



Choose a clean, dry place if you have to store the oven temporarily, as dust and moisture can damage the appliance.



**When steam function is in use, opening the door will release an amount of steam.
It's recommended to not open the door until the program is finished.**

ENVIRONMENTAL ASPECTS

Disposal of the appliance and packaging

This product is made from sustainable materials. However, the appliance must be disposed of responsibly at the end of its useful life. The government can provide you with information about this.

The appliance packaging can be recycled. The following materials have been used:

- cardboard;
- polyethylene film (PE);
- CFC-free polystyrene (hard PS foam).

Dispose of these materials responsibly in accordance with legal provisions.



The product has a pictogram of a crossed-out waste container. This indicates that household appliances must be disposed of separately. This means that the appliance may not be processed via the regular waste flow at the end of its useful life. You should take it to a special municipal waste depot or a sales outlet that offers to do this for you.

Collecting household equipment separately prevents harm to the environment and public health. The materials used in manufacturing this appliance can be recycled, which provides considerable savings in energy and raw materials.

Declaration of Conformity

CE We hereby declare that our products satisfy the applicable European Directives, Orders and Regulations, as well as the requirements stated in the referenced standards.



The appliance rating label is located on the inside of the appliance.

When contacting the service department,
have the complete type number to hand.

You will find the addresses and phone numbers of the service
organisation on the guarantee card.

The instructions for use can also be found on our website:
www.asko.com

 **ASKO**



687728

en (09-23)