

USER MANUAL

Dishwasher

EN

DWC6422BIW

DWC6422BIS

DWC6422BIWUK

DWC6422BISUK

Contents

Your dishwasher	3	Remote start the dishwasher	24
Safety instructions	4	Settings	26
Sani lock	5	Care and cleaning	31
Lock	5	Top up rinse aid	31
Installation	5	Top up salt	31
Overflow guard	5	Top up auto dose	31
Packaging	5	Clean the automatic dosing compartment ...	31
Disposal	5	Clean the filters	32
Symbols on the appliance	6	Cleaning the spray arms	33
Before washing for the first time	7	Clean the outside of the dishwasher	34
Water hardness	7	Run Self-cleaning	34
Basic settings	8	Remove blockages	35
Top up rinse aid	10	Winter storage/Transport	36
Top up salt	10	Troubleshooting	37
Top up auto dose	11	General	38
Greener dishwashing	12	WiFi	44
Save energy and water	12	Installation	45
Loading the dishwasher	13	Safety instructions	45
Fragile dishes	13	Transport protection for the door	46
Loading affects the results	13	Placing the dishwasher	46
The dishwasher's baskets	13	Affix the protective film	46
Upper basket	14	Adjust the height and slide the dishwasher into place	47
Lower basket	15	Drainage connection	48
Cutlery basket	16	Connection to water supply	49
Using the dishwasher	18	Electrical connection	50
Add detergent	18	Screwing the dishwasher into place	50
On/Off	19	Dishwasher toe kick	51
Select program	19	Service	52
Start/Stop	20	Information about your product	52
If you want to load more dishes	21	Contact your nearest service centre	52
Power failure	21	Spare parts	52
Once the program has finished	22	Number of cycles	52
The best drying results	22	Technical data and energy labelling	53
Unloading the dishwasher	22	Technical data	53
Program chart	23	Information for consumers	53
ASKO Connect Pro & ConnectLife	24	Information for test institute	53
ASKO Connect Pro	24	Declaration of conformity	53
ConnectLife	24		
Remote control the dishwasher	24		

Your dishwasher

Welcome to our growing ASKO family!

We are proud of our appliances. We hope that this appliance will be an appreciated and dependable aid for many years to come.

Please read the operating instructions before use. They include general tips, information about the settings and adjustments you can make, and the best way to take care of your appliance.

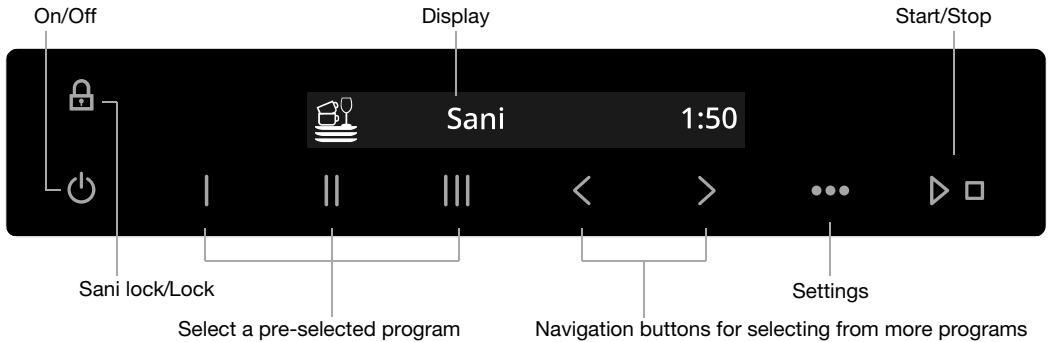

Symbols on the display:

- 🔓 Automatic door opening
- ✳️ Top up rinse aid
- 🧂 Top up salt
- 💧 Auto dose activated
- ⬆️+ Top up auto dose

- 📶 WiFi status Connected (Flashes when connecting)
- 📶 Remote control active

Text on the display:

- Clean the filters
- Run Self-cleaning
- See the chapter *Care and cleaning*.

Install the dishwasher, see the chapter *Installation*. Then open the door and press 🔓.

"Welcome to your new ASKO dishwasher. This is a first time setup." is shown on the display the first time the dishwasher is switched on. It is important that you choose the right settings to ensure good dishwashing results. See page 7.

ASKO Connect Pro is a web-based platform that enables you to organise, manage and monitor all your professional ASKO appliances regardless of where they are installed. Once you have connected a professional appliance in the ConnectLife app, a link to ASKO Connect Pro is shown. For more information, please see <https://professional.asko.com/>.

Safety instructions

- Read the user manual and keep it in a safe place!
- Number of standard place settings: 13
- Never use the dishwasher for any purpose other than that specified in these operating instructions.
- Do not load the dishwasher door or dishwasher baskets with anything other than dishes.
- Never leave the dishwasher door open as someone may trip on it. Push the baskets in to avoid risking the dishwasher tipping over.
- Use only dishwasher detergent!
- This machine can be used by children aged 8 and upwards, and by people with reduced physical capacity, mental ability, memory loss or lacking experience and knowledge. These individuals must be supervised when using the machine or have instructions on how to use the machine and understand the risks that can occur. Cleaning of the machine must not be carried out by children without supervision.
- Damaged supply cord must only be replaced by the manufacturer's service centre or someone similarly professionally qualified.
- This dishwasher is for household or similar use, such as:
 - staff kitchens in shops, offices and other workplaces.
 - farms.
 - for guests at hotels, motels and other types of accommodation.
 - bed & breakfast hotels.
- Never place dishes with solvent residues in the dishwasher due to the risk of explosion. Nor may dishes that contain ash, wax or lubricants be washed in the dishwasher.
- Children must be watched. Do not allow children to use or play with the dishwasher. Be especially vigilant when the door is open. Some detergent may remain inside! After adding detergent, always start the dishwasher immediately.

WARNING!

Knives and other pointed items must be placed with the points down in the cutlery basket or horizontally in other baskets.

WARNING!

Children must be supervised – dishwasher detergent is corrosive!

Sani lock

To prevent the risk of burn injuries, the door cannot be opened while the dishwasher temperature exceeds 65 °C.

Lock

You can activate the Lock setting to prevent children or persons with reduced mental capabilities from starting the dishwasher. See the chapter *Settings*. You can temporarily deactivate and activate the Lock function by pressing and holding  and **•••** for three seconds.

Installation

See the chapter *Installation*.

Overflow guard

The overflow guard starts pumping out the water and turns off the water supply if the water level in the dishwasher exceeds the normal level. If the overflow guard is triggered, F54 (Overfilling water) appears on the display. Turn off the water tap and contact your nearest service centre. (To avoid water leakage outside the dishwasher, do not remove the plug from the wall socket until the water tap on the supply line has been turned off!)

Packaging

The outer packaging protects the product during transport. The packaging material is recyclable. Separate the different packaging materials to help reduce raw material use and waste. Your dealer can take the packaging for recycling or direct you to the nearest recycling centre. The packaging is comprised of:

- Corrugated cardboard made from up to 100% recycled material.
- Expanded polystyrene (EPS) with no added chlorine or fluorine.
- Supports made from untreated wood.
- Protective plastic made from polyethylene (PE).

Disposal

The dishwasher is manufactured and labelled for recycling. When the dishwasher has reached the end of its service life and is to be disposed of, it should immediately be made unusable. Pull out the power cable and cut it as short as possible. Remove the light source/light sources.

Safety instructions

Contact your local authority for information about where and how your dishwasher should be correctly recycled.

Symbols on the appliance



Read the user manual.



Recycle as electrical waste.



Approved in accordance with the relevant EU directives.



Approved in accordance with the relevant UK legal requirements.

Before washing for the first time

Water hardness

In order to achieve good dishwashing results, the dishwasher needs soft water (water with low mineral content). Hard water leaves a white coating on dishes and the dishwasher.

Checking water hardness

Water hardness is specified using German degrees of water hardness (°dH), French degrees of water hardness (°fH), English degrees of water hardness (°eH) or millimoles per litre (mmol/l).

A water supply with a water hardness in excess of 5°dH (9°fH / 6°eH / 0.9 mmol/l) must be softened. This is done automatically with the aid of the built-in water softener. In order for the water softener to function properly, its settings must be adjusted to the hardness of the water supply. Once you have adjusted the water softener settings, add detergent and rinse aid in doses suitable for soft water.

Contact the local waterworks to check the water hardness in your area.

Make a note of the water hardness: _____

German water hardness scale	French water hardness scale	Recommended setting
0-3°dH	0-5°fH	0
4-5°dH	6-9°fH	1
6-8°dH	10-14°fH	2
9-11°dH	15-20°fH	3
12-14°dH	21-25°fH	4
15-19°dH	26-34°fH	5
20-24°dH	35-43°fH	6
25-29°dH	44-52°fH	7
30-39°dH	53-70°fH	8
40°dH	71°fH	9

If the water hardness exceeds 20°dH (36°fH), we recommend connecting an external water softener.

Increased consumption during regeneration

The dishwasher's built-in water softener is regularly regenerated to maintain its function. Regeneration extends the dishwashing program and increases energy and water consumption. Just how often the dishwasher's water softener is regenerated depends on the selected setting.

Example: If the Eco program is run with a water hardness of 14°dH (25°fH / 18°eH / 2.5 mmol/l), the water softener is regenerated at regular intervals (after 5 dishwashing cycles), energy consumption increases by 0.015 kWh, and water consumption increases by 2.3 litres, while the program time is extended by 3 minutes. Regeneration takes place during the program's main wash.

Before washing for the first time

WARNING!

Hard water leaves a white coating on dishes and inside the dishwasher. It is therefore important that you select the right setting for the water softener! See Water hardness.

Never run the dishwasher with an empty salt compartment if the water supply has a water hardness in excess of 5°dH (9°FH / 6°eH / 0.9 mmol/l).

Basic settings

Open the door. Press .

"**Welcome to your new ASKO dishwasher. This is a first time setup.**" is shown on the display. It is important that you choose the right settings to ensure good dishwashing results.

Select setting with < or >. Confirm selected setting with **...**.

Settings	
Language	Select the language to be shown on the display.
Rinse aid 0/1/2/3/4/5 <i>Pre-selected at factory: 4</i>	Drying is faster and a better result is achieved if you use rinse aid. You will also achieve a better dishwashing result with clear and spotless dishes. The rinse aid dispenser can be adjusted between 0 (Off) and 5 (High dosage).
Water hardness 0/1/2/3/4/5/6/7/8/9 <i>Pre-selected at factory: 6</i>	Adjusting the water softener. Select a setting depending on the hardness of the water supply. It is important that this setting is correct! For a water supply with a hardness above 5 °dH (9 °fH / 6 °eH / 0.9 mmol/l), fill with salt. <i>For a water supply with a hardness below 6°dH (10°fH / 7°eH / 1.0 mmol/l), select 0. The water softener is deactivated and no salt needs to be added.</i>
TAB On/Off (All-in-one detergent) <i>Pre-selected at factory: Off</i>	Activate the setting when using all-in-one detergent containing rinse aid. (Also applies to dishwasher detergent gel for automatic dosing that contains rinse aid.) <i>This setting reduces the rinse aid dosage and affects how often the dishwasher's built-in softener is regenerated.</i>
Auto dose Off, 15-40 ml <i>Pre-selected at factory: Off</i>	Activate this setting if you want to use automatic dosing of detergent. This dishwasher is fitted with a water softener, so use detergent and rinse aid doses suitable for soft water.
WiFi WiFi status	Connect the dishwasher to your wireless network to be able to remote control the dishwasher using the <i>ConnectLife</i> app.
WiFi connection On/Off	After connecting the dishwasher to your local network, you can select <i>WiFi connection Off</i> to deactivate the connection. Select <i>WiFi connection On</i> to reconnect to the same network.

Before washing for the first time

Settings	
Connection setup	<p>Connect the dishwasher to your wireless network and pair with your smartphone/tablet.</p> <ul style="list-style-type: none">• In the ConnectLife application, go to the »Add devices« menu and select the appropriate type of device. Then scan the QR code (it can be found on the serial number plate of the appliance; you can also enter the AUID/SN number manually).• Select <i>Connection setup</i>.
Add device	<p>Pair more devices/users with the dishwasher.</p> <ul style="list-style-type: none">• In the ConnectLife application, go to the »Add devices« menu and select the appropriate type of device. Then scan the QR code (it can be found on the serial number plate of the appliance; you can also enter the AUID/SN number manually).• Select <i>Add device</i>.
Remove all devices	<p>Select <i>Remove all devices</i> to remove all connected devices/users.</p>
WiFi factory reset	<p>Select <i>WiFi factory reset</i> to restore the default factory settings.</p>
Exit	<p>Select <i>Exit</i> to exit the menu for WiFi, press •••.</p>
Save and exit	<p>Select <i>Save and exit</i>, press •••.</p>

To change the selected setting, see the chapter *Settings*.

Before washing for the first time

* Top up rinse aid

Top up the rinse aid compartment with rinse aid if you have selected Rinse aid 1 - 5.

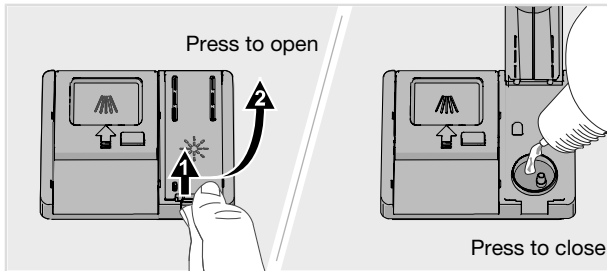

1. Open the rinse aid compartment lid.
2. Carefully top up with rinse aid to the level marked **MAX**.
3. Wipe up any splashes of rinse aid around the compartment.
4. Close the lid firmly.

§ Top up salt

For a water supply with a hardness above 5 °dH (9 °fH / 6 °eH / 0.9 mmol/l), fill with salt.

Add salt to the salt compartment if you have selected Water hardness 1 - 9.

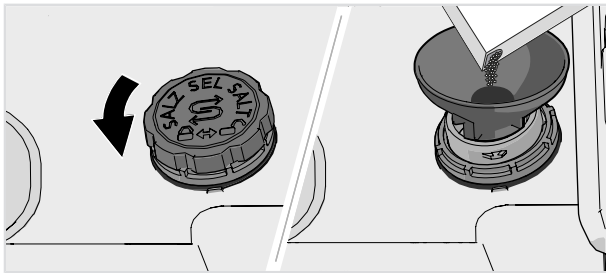

1. Remove the salt compartment lid by turning it anticlockwise.
2. Place the funnel supplied with the dishwasher in the salt compartment top-up hole. Before washing for the first time, pour in about 1 l of water. (Water is only needed the first time.)
3. Add enough salt to fill the salt compartment (max. 750 gram). Use special dishwasher salt.
4. Wipe away excess salt and turn the lid clockwise until in the closed position.

⚠ WARNING!

In order to avoid rust stains a dishwashing program must be started immediately after adding salt.

Never pour dishwasher detergent into the salt compartment. This destroys the water softener!

Before washing for the first time

Top up auto dose

Fill the automatic dosing compartment with dishwasher detergent gel if you have activated the Auto dose setting.

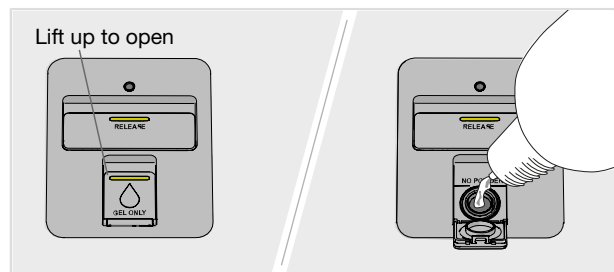

1. Open the lid of the automatic dosing compartment for dishwasher detergent gel.
2. Carefully add dishwasher detergent gel to the level marked **MAX**.
3. Clean up any excess dishwasher detergent gel outside the compartment.
4. Close the lid firmly.

NOTE!

Use only dishwasher detergent gel in the automatic dosing compartment! Do not use dishwasher detergent powder. Washing up liquid must not be used as the foam that forms prevents the dishwasher from operating effectively.

Some thick dishwasher detergent gels are not suitable for the automatic dosing compartment. Add very thick dishwasher detergent gel into the manual detergent compartment. See the detergent manufacturer's recommendations.

Dishwasher detergent gel has a milder formula than dishwasher detergent powder or all-in-one detergent with bleaching agent. This means that dishwasher detergent gel may prove less effective at removing stains caused by, for example, lipstick and tea/coffee. If necessary, on such occasions dishwasher detergent powder or all-in-one detergent with bleaching agent can be added to the manual detergent compartment (when Auto dose is activated). See *Add detergent*.

Dosing of dishwasher detergent gel

Dishwasher detergent gel is dispensed during the main wash for all programs except Self-cleaning. A little extra dishwasher detergent gel is also dispensed during the prewash in the following programs:

Intensive, Universal

Greener dishwashing

Save energy and water

When using a dishwasher in a residential setting, less energy and water are generally used compared to washing the dishes by hand.

Do not rinse under running water

Do not rinse the dishes under running water as this will lead to increased energy and water consumption. Simply scrape off large food particles before loading the dishwasher.

Choose a green detergent

Read the environmental declaration on the packaging!

Too much detergent, rinse aid and salt can result in less effective dishwashing and also entail greater environmental impact.

Run a fully loaded dishwasher

Save energy and water by waiting until the dishwasher is full before running a program (see number of standard place settings). Use the Rinse and hold program to rinse the dishes if there are any unpleasant odours.

Run programs at a lower temperature

If the dishes are only slightly dirty, you can select a program with a low temperature.

Select dishwashing program – Eco

This program is suitable for washing normally soiled dishes and is the most effective program in terms of combined energy and water consumption. This program is used to assess compliance with EU legislation on ecodesign.

The dishwashing program is designed for an effective wash using as little energy and water as possible. The program washes at a low temperature for a long time.

Select setting – Automatic door opening

Better drying results are achieved if you use the Automatic door opening option, which automatically opens the dishwasher door. Wait until the dishwasher indicates that the program has ended and the dishes have cooled before unloading the dishwasher. (If the dishwasher is built-in, the surrounding furnishings must be resistant to any condensation from the dishwasher.)

Fragile dishes

Some cookware is not dishwasher safe. This can be for several reasons. Some materials cannot withstand high heat, others can be damaged by dishwasher detergent.

Exercise caution with, for example, handmade items, fragile decoration, crystal/glassware, silver, copper, tin, aluminium, wood and plastic. Look for the "Dishwasher safe" marking.

Fragile decoration

Porcelain with decoration on top of the glazing (the items feel rough) should not be washed in a dishwasher.

Crystal/Glass

Wash fragile items made of crystal/glass using the gentle dishwashing program Crystal glass. Remember to use a small amount of detergent and to place items so that they do not touch each other during the wash.

Drying is faster and a better result is achieved if you use rinse aid. You will also achieve a better dishwashing result with clear and spotless dishes.

Hand-painted glassware, as well as antique and very fragile items, should not be washed in a dishwasher.

Silver

Silver and stainless steel items should not come into contact, as the silver can become discoloured.

In order to avoid marks and tarnishing, separate dishes made from different metals, such as silver, stainless steel and aluminium.

Aluminium

Aluminium can lose its shine if washed in a dishwasher. However, good quality aluminium pans can be washed in a dishwasher, even if some of the shine will be lost.

Cutlery with glued handles

Some types of glue are not dishwasher safe. In such cases, the handles may loosen.

Loading affects the results

Load the dishes carefully to ensure the best washing and drying results with the lowest possible energy and water consumption. Give your dishwasher the best chance to reach and clean all surfaces, as well as to dry the dishes as thoroughly as possible.

- All dirty surfaces should face inwards and downwards!
- Dishes should not be placed in or on each other.
- Angle dishes with hollows, such as cups, so that the rinse water will run off. This is also important for plastic items.
- Make sure small items cannot fall through the dishwasher basket; place them in the cutlery basket.

NOTE!

Check that the spray arms can rotate freely.

The dishwasher's baskets

The dishwasher is equipped with an upper basket and a lower basket with a cutlery basket.

Loading the dishwasher

The appearance of the baskets may differ depending on the dishwasher setup.

Upper basket

Place glasses, cups, bowls, side plates and saucers in the upper basket. All dirty surfaces should face inwards and downwards! Wine glasses are placed on the wine glass shelf and knives are placed in the knife stand on the right.

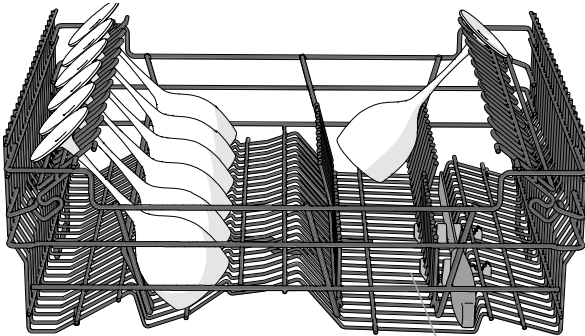
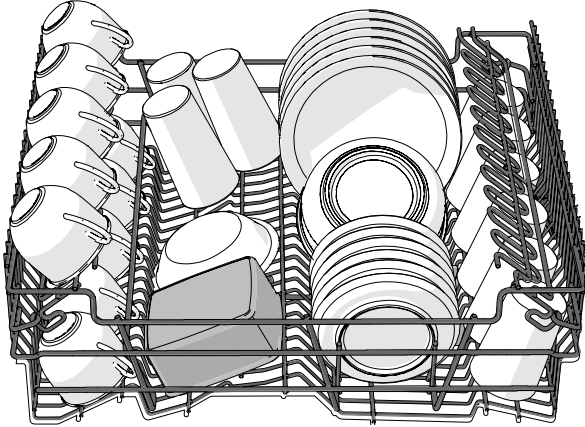

Knife stand

Raising the upper basket

1. Pull out the upper basket.
2. Grab the sides of the upper basket with both hands and lift it up.

Lowering the upper basket

1. Pull out the upper basket.
2. Grab the sides of the upper basket with both hands and push in the two locking handles to lower the upper basket.

Loading the dishwasher

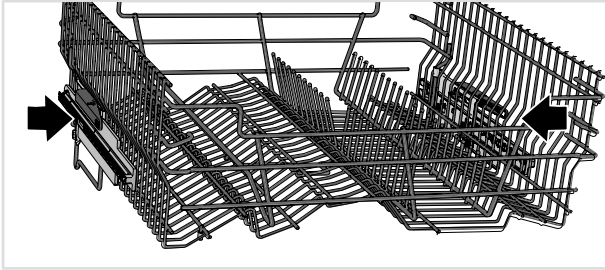

Lower basket

Place plates, side plates, serving dishes, pots and cutlery (in the cutlery basket) in the lower basket.

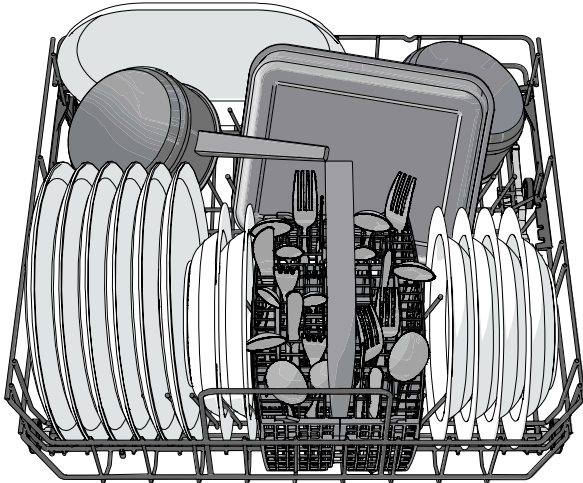

Adjustable plate supports

The adjustable plate supports can be adjusted to suit the dishes. Release the plate supports by pushing them inwards before repositioning them. The plate supports can also be folded down to make it easier to load pots and bowls.

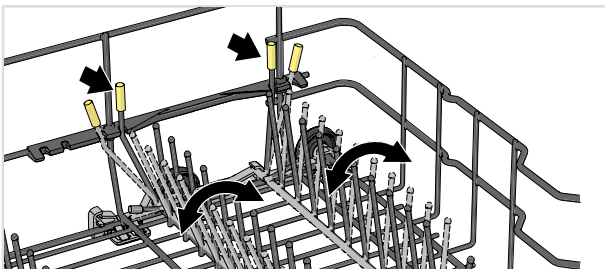

Loading the dishwasher

Washing large plates

You can adjust the lower basket for plates with a diameter of 25-31 cm by moving the adjustable plate supports and their fixtures to increase the distance between the tine rows.

Accessory

Buy a wine glass shelf with space for six tall¹⁾ wine glasses. The wine glass shelf is designed to ensure optimal washing and drying results with tall wine glasses. The wine glass shelf is placed in the rear section of the lower basket. This accessory is available where you bought the dishwasher.

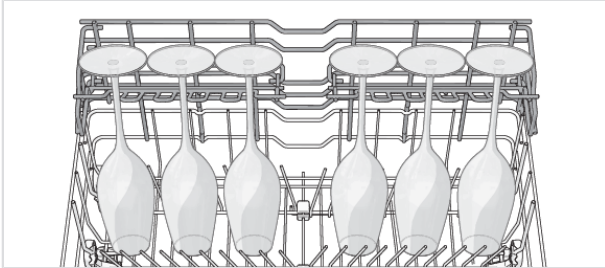

Cutlery basket

Place cutlery with the handles facing down, except for knives, and spread them out as much as possible. Ensure that spoons do not stack inside each other.

The cutlery basket is best placed in the middle at the front of the lower basket to best utilise dishwashing performance from the unique spray zone intended for the cutlery basket.

⚠ WARNING!

Knives and other pointed items must be placed with the points down in the cutlery basket or horizontally in other baskets.

Fold-down section for small items

The cutlery basket has a fold-down section in the middle for small items or small shafts (such as electric whisk attachments).

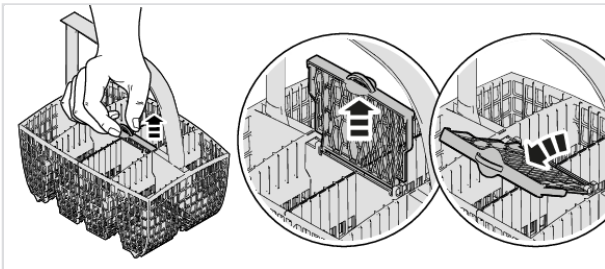

¹⁾ Height: max. 25 cm, Diameter: max. 7.5 cm

Cutlery basket with lid

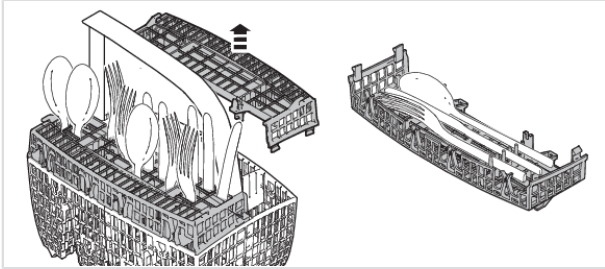

Accessory

Buy a mini cutlery basket. The extra cutlery basket is flexible and can be dismantled and attached to the lower basket or the large cutlery basket to make an extra large cutlery basket. This accessory is available where you bought the dishwasher.

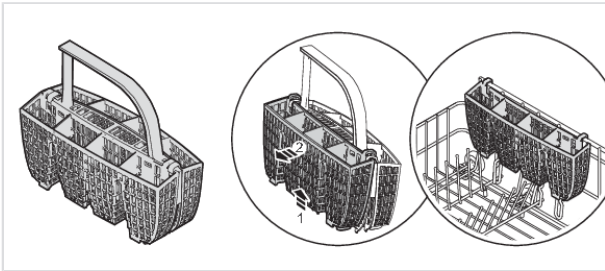

Using the dishwasher

Add detergent

You have two options for adding detergent – manual or automatic. To activate Auto dose, see the chapter *Settings*. The manual detergent compartment can be used as a supplement even when Auto dose is activated (e.g. for dishwasher detergent with bleaching agent or if the automatic dosing compartment is empty).

Follow the instructions on the detergent packaging. This dishwasher is fitted with a water softener, so use detergent and rinse aid doses suitable for soft water.

Manual detergent compartment

Choose a detergent intended for professional dishwashers to ensure optimal dishwashing results.

Do not add detergent to the manual detergent compartment when using automatic detergent dosing! Too much detergent can result in less effective dishwashing and also entails greater environmental impact.

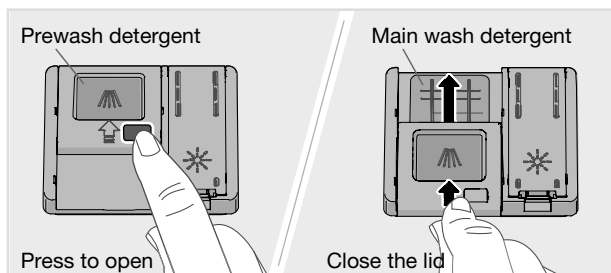

The detergent compartment must be dry when adding detergent. There is one compartment for the prewash and one for the main wash. If dishwasher detergent powder or dishwasher detergent gel is used, you can add a small amount of the detergent to the prewash compartment. Contact the detergent manufacturer if you have questions about the detergent.

NOTE!

Use only dishwasher detergent! Washing up liquid must not be used as the foam that forms prevents the dishwasher from operating effectively.

All-in-one detergent

There are many types of all-in-one detergents on the market. Read through the directions for these products carefully.

Activate the TAB setting when using an all-in-one detergent that contains rinse aid.

Dishwasher tablets are not recommended for programs lasting less than 75 minutes. Use dishwasher detergent powder or dishwasher detergent gel instead.

NOTE!

Optimal washing and drying results are achieved by using dishwasher detergent together with separately dispensed rinse aid and salt.

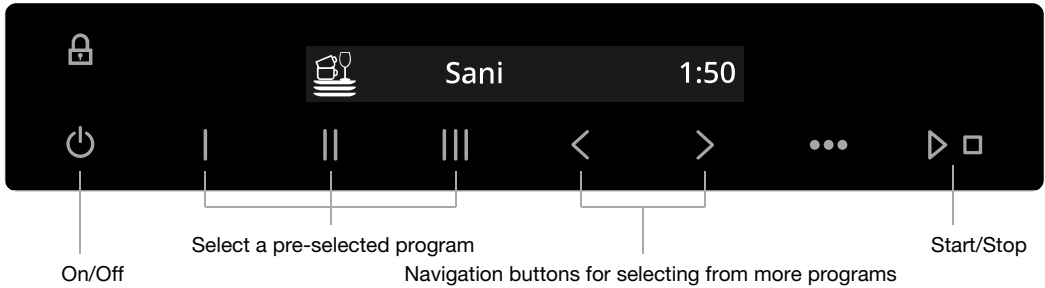

On/Off

Open the door and press . Also turn on the water tap if it is turned off.

Select program

Eco is always pre-selected. To select another program, press I, II or III. You can also select a program by pressing < or > until the desired program is shown on the display.

Select a program to suit the type of dishes and how dirty they are.



Eco²⁾

This program is suitable for washing normally soiled dishes and is the most effective program in terms of combined energy and water consumption. This program is used to assess compliance with EU legislation on ecodesign.



Crystal glass

A gentle dishwashing program with a low temperature for washing fragile items made of crystal/glass. Remember to use a small amount of detergent and to place items so that they do not touch each other during the wash. See also *Fragile dishes* in the chapter *Loading the dishwasher*. Porcelain that has just been used without dried leftovers can also be washed using this program.



Intensive

A program with a high temperature for dissolving grease on very dirty dishes, such as pans, casserole dishes and oven dishes. If these dishes do not completely fill the dishwasher, you can add plates and other dishes.



Quick

This program is used for glasses and porcelain that is slightly dirty, such as coffee cups.



Rinse and hold

Used to rinse dishes while you wait for the dishwasher to become fully loaded.

Using the dishwasher



Universal

Powerful programme for daily use that can remove dried leftovers, but is not intended for burnt food, such as on oven dishes.



Sani²⁾

This program is ideal to use when hygiene demands are set high. The temperature of the main wash is 60 °C. The final rinse is 85 °C for 4 minutes.

 To prevent the risk of burn injuries, the door cannot be opened while the dishwasher temperature exceeds 65 °C.



Sani quick²⁾

Select Sani quick if you want a quicker program that still fulfils hygiene demands. The temperature of the main wash is 50 °C. The final rinse is 85 °C for 4 minutes.

 To prevent the risk of burn injuries, the door cannot be opened while the dishwasher temperature exceeds 65 °C.



Self-cleaning

Self-cleaning program for hygienic cleaning of the dishwasher tub, spray arms and spray pipes.

This program should be run (with no dishes in the machine) using dishwasher detergent or citric acid – add it to the dishwasher's manual detergent compartment. (Detergent is not automatically dispensed with the Auto dose function.) Special dishwasher cleaners are also available on the market. For the removal of limescale deposits, see *Dishwasher tub* in the chapter *Care and cleaning*.

▶ □ Start/Stop

Press ▶ □ until the display shows "Program started, close door". This indicates that the dishwasher is ready to start. Close the door properly, otherwise the dishwasher will not start.

If the dishwasher is not started or the door is not closed within 2 minutes of the last time the control panel was pressed, the machine switches off.

To remote start the dishwasher, see the chapter *ASKO Connect Pro & ConnectLife*.

Stopping or changing a program

If you want to change program after starting the dishwasher, open the door then press and hold ▶ □ for three seconds. Add more detergent if the lid of the detergent dispenser has opened. Then select a new program, press ▶ □ and close the door.

Remaining time

Once you have chosen a program, the time the programme took when last used is displayed.

Once you have started the dishwasher, the display shows the remaining program time. The remaining time is updated during the drying phase.

²⁾ Program button I/II/III.

To change which pre-selected programs are assigned to the program buttons (I/II/III), select the desired program in the menu and then press and hold the desired program button for three seconds.

Using the dishwasher

This may differ somewhat from time to time depending on the temperature of the water supply, the amount of dishes, the ambient temperature and other factors.

During the first run of each program, the remaining time displayed can be slightly misleading, as the dishwasher is estimating the time. When you run the program a second time, the dishwasher will calculate the remaining time based on the previous duration of the program.

If you want to load more dishes³⁾

Open the door. The dishwasher stops automatically. Add the dishes and close the door. After a while, the dishwasher continues the program.

If the dishwashing program was remote started, the interrupted program will continue once the door is closed. You can monitor the dishwasher using the *ConnectLife* app and remote stop the program, although you will not be able to remote start it again.

Power failure

If the dishwasher is turned off due to a power failure when a dishwashing program is running, the program continues when power is restored. If the power is cut during drying, the program is interrupted.

If the dishwashing program was remote started and has not ended, the program will continue once the power is restored. You can monitor the dishwasher using the *ConnectLife* app and remote stop the program, although you will not be able to remote start it again.

If you open the door for more than 2 minutes during drying, the program will be interrupted.

Emergency opener

If the dishwasher loses power when Sani lock or Lock is activated, the door can be opened with the emergency opener.

Push the emergency opener into the bottom edge of the door. Pull the emergency opener until the dishwasher door opens. Then refit the emergency opener.

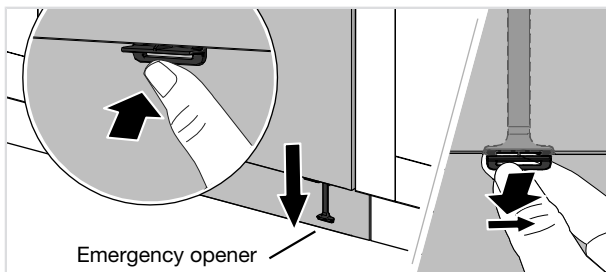

WARNING!

To prevent the risk of burn injuries, wait until the dishwasher has cooled before opening the door with the emergency opener!

Exercise caution! The edges may be sharp. Wear protective gloves!

³⁾ You can load more dishes within 5 minutes after you have started the dishwasher.

Using the dishwasher

Once the program has finished

Once the program has finished, "Program done" appears on the display.

At the end of the program one short signal will sound. Chapter *Settings* describes how to change this function.

The dishwasher switches off automatically after the program ends. Shut off the water tap after each use (if required by your insurance company).











The best drying results

- Fully load the dishwasher.
- Angle dishes with hollows, such as cups, so that the rinse water will run off. This is also important for plastic items.
- Top up with rinse aid or increase the rinse aid dosage setting.
- Activate the Automatic door opening option.
- Allow the dishes to cool before unloading the dishwasher.

Unloading the dishwasher

Hot porcelain is more fragile. Leave the dishes to cool in the dishwasher before unloading them.

Unload the lower basket first to avoid any water drops from the upper basket falling onto the dishes in the lower basket.

Program	Number of prewashes	Main wash	Number of rinses	Final rinse	Consumption values ¹⁾				
					Cold water ²⁾		Hot water ³⁾		Water cons. (liter)
					Dishwashing time (approx. hrs:min)	Energy (approx. kWh)	Dishwashing time (approx. hrs:min)	Energy (approx. kWh)	
 Eco 4),  5)		50 °C	2	46 °C	3:15	0.83	3:00	0.4	12.2
 Crystal glass		45 °C	2	50 °C	1:40	0.8	1:20	0.3	12.5
 Intensive	2	70 °C	2	70 °C	2:55	1.7	2:35	1.0	20.0
 Quick		≤60 °C	3	≤60 °C	0:40	0.9	0:25	0.3	17.0
 Rinse and hold			1		0:07	0.01	0:07	0.01	4.5
 Universal,  5)	1	60 °C	2	60 °C	2:15	1.2	1:55	0.6	15.5
 Sani	1	60 °C	2	85 °C	1:35	1.8	1:20	0.9	16.0
 Sani quick	1	50 °C	3	85 °C	1:10	1.6	0:45	0.8	19.0
 Self-cleaning		70 °C	2	85 °C	1:05	1.4	1:05	1.0	12.0

1) Consumption values vary depending on the temperature of the incoming water, room temperature, load size, selected additional functions and more.

2) Connection to cold water, approx. 15 °C.

3) Connection to hot water, approx. 60 °C.

4) This program is suitable for washing normally soiled dishes and is the most effective program in terms of combined energy and water consumption. This program is used to assess compliance with EU legislation on ecodesign.

5) Option: Auto door open

ASKO Connect Pro & ConnectLife

ASKO Connect Pro

ASKO Connect Pro is a web-based platform that enables you to organise, manage and monitor all your professional ASKO appliances regardless of where they are installed. Once you have connected a professional appliance in the ConnectLife app, a link to ASKO Connect Pro is shown. For more information, please see <https://professional.asko.com/>.

ConnectLife

ConnectLife is a smart home platform that connects people, devices and services. The ConnectLife application includes advanced digital services and carefree solutions that allow users to monitor and control appliances, receive notifications from a smartphone, and update software (supported features may vary depending on your appliance and the region/country in which you are located).

To connect your smart device, you need a home Wi-Fi network (only 2.4 GHz networks are supported) and a smartphone equipped with the application ConnectLife.



To download the ConnectLife application, scan the QR code or search for ConnectLife in your favourite app store.

1. Install the ConnectLife application and create an account.
2. In the ConnectLife application, go to the »Add devices« menu and select the appropriate type of device. Then scan the QR code (it can be found on the serial number plate of the appliance; you can also enter the AUID/SN number manually).
3. The application then guides you through the entire process of connecting the appliance to your smartphone.
4. After a successful connection, the appliance can be operated remotely via the mobile application.

Remote control the dishwasher

The dishwasher's network symbol  is shown on the display when the dishwasher is paired with a smartphone/tablet. You can use the *ConnectLife* app to monitor the dishwasher and change settings.

Network symbol on the display

<i>Flashing 0.5 sec on/off</i>	The dishwasher is ready to be connected to your wireless network or paired with your smartphone/tablet.
<i>Flashing 1.0 sec on/off</i>	The dishwasher is connected to your wireless network.
<i>Glows</i>	The dishwasher is connected to your wireless network and the cloud.

Remote start the dishwasher

To remote start the dishwasher, press **•••**. Select Remote start On. Close the door.

In the *ConnectLife* app, select and start a program.

If the door is not closed within 2 minutes, the machine switches off.



NOTE!

The dishwasher can always be used without the app. When the dishwasher's control panel is pressed, commands from the *ConnectLife* app are blocked for 10 seconds.





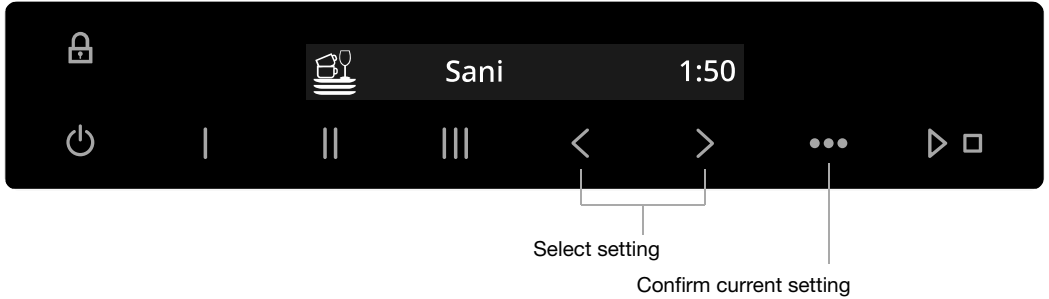

If you have any questions, please visit us at www.connectlife.io.

Settings

Press .

To open the Settings, press  or  until Settings is shown on the display and confirm your selection with .



Settings	Alternatives	
Lock 	<i>On/Off</i>	To prevent children or persons with reduced mental capabilities from starting the dishwasher, the Lock setting can be activated. To temporarily deactivate or activate the Lock setting, press and hold  and  for three seconds.
Delayed start	<i>Off/1-24 hours</i>	When you select Delayed start, the dishwasher will start 1-24 hours after you press   . <i>This Delayed start function is available for some programs.</i>
Remote start	<i>On/Off</i>	Activate the setting to be able to remote start the dishwasher. Remote start On is shown on the dishwasher display. Activate the setting each time you want to remote start the dishwasher. <i>The setting can be selected with WiFi status Connected.</i>
Auto door open 	<i>On/Off</i>	The dishwasher door opens automatically, which shortens the program time and improves the drying results. Wait until the dishwasher indicates that the program has ended and the dishes have cooled before unloading the dishwasher.

Settings	Alternatives	
Auto dose	<i>Off, 15-40 ml</i>	<p>Activate this setting if you want to use automatic dosing of detergent.</p> <p>This dishwasher is fitted with a water softener, so use detergent and rinse aid doses suitable for soft water.</p> <p><i>The exact dosage depends on the selected program.</i></p>
TAB (All-in-one detergent)	On/Off	<p>Activate the setting when using all-in-one detergent containing rinse aid. (Also applies to dishwasher detergent gel for automatic dosing that contains rinse aid.)</p> <p><i>This setting reduces the rinse aid dosage and affects how often the dishwasher's built-in softener is regenerated.</i></p>
Feedback volume	0/1/2/3	A beep confirms that the control panel has been pressed.
Exit		Select <i>Exit</i> to exit the menu for Settings, press ●●●.

Settings

To open the Advanced Settings, press < or > until Advanced Settings is shown on the display and confirm your selection with ●●●.

Press: I, II, I, III

Advanced Settings	Alternatives		
Language	You can choose the language used for the display.		
WiFi WiFi status	The current WiFi status is shown on the display. Connect the dishwasher to your wireless network to be able to remote control the dishwasher using the <i>ConnectLife</i> app.		
WiFi connection	<i>On/Off</i> After connecting the dishwasher to your local network, you can select <i>WiFi connection Off</i> to deactivate the connection. Select <i>WiFi connection On</i> to reconnect to the same network.		
Connection setup	Connect the dishwasher to your wireless network and pair with your smartphone/tablet. <ul style="list-style-type: none"> In the ConnectLife application, go to the »Add devices« menu and select the appropriate type of device. Then scan the QR code (it can be found on the serial number plate of the appliance; you can also enter the AUID/SN number manually). Select <i>Connection setup</i>. 		
Add device	Pair more devices/users with the dishwasher. <ul style="list-style-type: none"> In the ConnectLife application, go to the »Add devices« menu and select the appropriate type of device. Then scan the QR code (it can be found on the serial number plate of the appliance; you can also enter the AUID/SN number manually). Select <i>Add device</i>. 		
Remove all devices	Select <i>Remove all devices</i> to remove all connected devices/users.		
WiFi factory reset	Select <i>WiFi factory reset</i> to restore the default factory settings.		
Exit	Select <i>Exit</i> to exit the menu for WiFi, press ●●●.		
Select programs	<table border="0"> <tr> <td>Eco <i>On/Off</i> Crystal glass <i>On/Off</i> Intensive <i>On/Off</i> Quick <i>On/Off</i> Rinse and hold <i>On/Off</i> Universal <i>On/Off</i> Sani <i>On/Off</i> Sani quick <i>On/Off</i> Self-cleaning <i>On/Off</i></td> <td> Programs can be shown or hidden in the menu. Choose between On and Off. (Eco cannot be hidden in the menu.) To change which pre-selected programs are assigned to the program buttons (I/II/III), select the desired program in the menu and then press and hold the desired program button for three seconds. </td> </tr> </table>	Eco <i>On/Off</i> Crystal glass <i>On/Off</i> Intensive <i>On/Off</i> Quick <i>On/Off</i> Rinse and hold <i>On/Off</i> Universal <i>On/Off</i> Sani <i>On/Off</i> Sani quick <i>On/Off</i> Self-cleaning <i>On/Off</i>	Programs can be shown or hidden in the menu. Choose between On and Off. (Eco cannot be hidden in the menu.) To change which pre-selected programs are assigned to the program buttons (I/II/III), select the desired program in the menu and then press and hold the desired program button for three seconds.
Eco <i>On/Off</i> Crystal glass <i>On/Off</i> Intensive <i>On/Off</i> Quick <i>On/Off</i> Rinse and hold <i>On/Off</i> Universal <i>On/Off</i> Sani <i>On/Off</i> Sani quick <i>On/Off</i> Self-cleaning <i>On/Off</i>	Programs can be shown or hidden in the menu. Choose between On and Off. (Eco cannot be hidden in the menu.) To change which pre-selected programs are assigned to the program buttons (I/II/III), select the desired program in the menu and then press and hold the desired program button for three seconds.		

Advanced Settings	Alternatives	
Display Logotype	<i>On/Off</i>	Setting to hide the logo shown on the display.
Display Brightness	<i>1/2/3/4</i>	For adjusting the brightness of the display.
Notification volume	<i>0/1/2/3</i>	<p>The buzzer indicates when a dishwashing program has ended.</p> <p><i>Error messages are always indicated by a loud buzzer.</i></p>
Rinse aid	<i>0/1/2/3/4/5</i>	<p>Setting for rinse aid dosage. The rinse aid dispenser can be adjusted between 0 (Off) and 5 (High dosage).</p> <p>Increase the rinse aid dosage:</p> <ul style="list-style-type: none"> • If the dishes have water marks. <p>Decrease the rinse aid dosage:</p> <ul style="list-style-type: none"> • If the dishes have a sticky white/blue film. • If the dishes are streaked. • Build-up of foam. If you have very soft water, the rinse aid can be diluted 50:50 with water.
Water hardness	<i>0/1/2/3/4/5/6/7/8/9</i>	<p>Adjusting the water softener. Select a setting depending on the hardness of the water supply. It is important that this setting is correct!</p> <p>See <i>Water hardness</i> in the chapter <i>Before washing for the first time</i>.</p> <p>For a water supply with a hardness above 5 °dH (9 °fH / 6 °eH / 0.9 mmol/l), fill with salt.</p> <p><i>For a water supply with a hardness below 6°dH (10°fH / 7°eH / 1.0 mmol/l), select 0. The water softener is deactivated and no salt needs to be added.</i></p>

Settings

Advanced Settings	Alternatives	
Interior light at power off	<i>On/Off</i>	Select whether the interior light is to be switched on when the dishwasher is turned off and the door is opened. (If \odot is turned on, the interior light is always switched on when the door is opened.)
Failure readout		Any error messages. <i>When contacting your service centre, you may be asked to provide the most recent error messages.</i>
Temperature unit	<i>°C/°F</i>	Temperatures can be displayed in °C (Celsius) or °F (Fahrenheit).
Block start when softener is empty	<i>On/Off</i>	Setting to prevent a dishwashing program from starting when the salt compartment is empty. (You can run 3 programs before the compartment is completely empty.) <i>This setting is not active if Water hardness is set to 0.</i>
Factory reset		Restores all settings to the factory defaults. Select Factory reset and press \blacktriangleright \square .
Exit		Select <i>Exit</i> to exit the menu for Settings, press $\bullet\bullet\bullet$.

* Top up rinse aid

When the rinse aid needs topping up, the symbol lights on the display.

See the chapter *Before washing for the first time*.

Ⓔ Top up salt

When the salt needs topping up, the symbol lights on the display.

See the chapter *Before washing for the first time*.

💧 Top up auto dose

When the dishwasher detergent gel needs topping up, the symbol appears on the display. (You can run 1-2 wash programs before the compartment is completely empty.)

See the chapter *Before washing for the first time*.

Clean the automatic dosing compartment

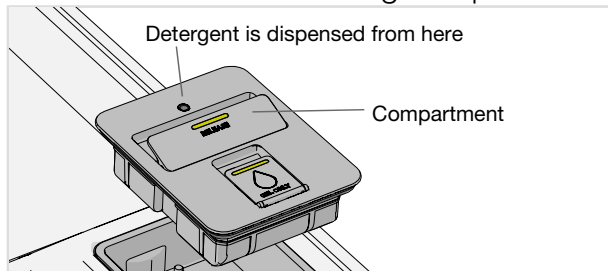

1. The compartment can be lifted out for cleaning and refilling.
2. Check that the dispensing hole is not blocked. Clean the compartment with hot water.

NOTE!

Important - refit the compartment. The dishwasher must not be used without the automatic dosing compartment in place!

Care and cleaning

Clean the filters

Coarse filter

The coarse filter traps larger food particles, which cannot get past the drainage pump. Empty the coarse filter when necessary. It should be cleaned at regular intervals depending on how often the dishwasher is used.

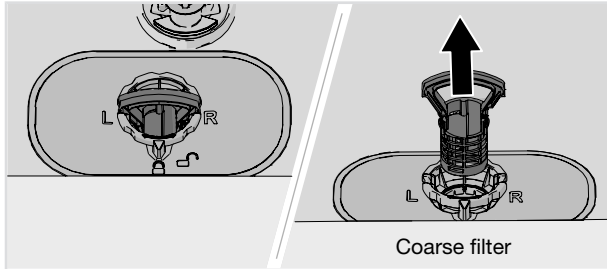

1. Lift the coarse filter by the handle.
2. Empty the coarse filter.
3. Refit the coarse filter. Press it down until it clicks into place.

Fine filter

Debris that collects on the fine filter is automatically rinsed away during each wash. Clean the fine filter when necessary. It should be cleaned at regular intervals depending on how often the dishwasher is used.

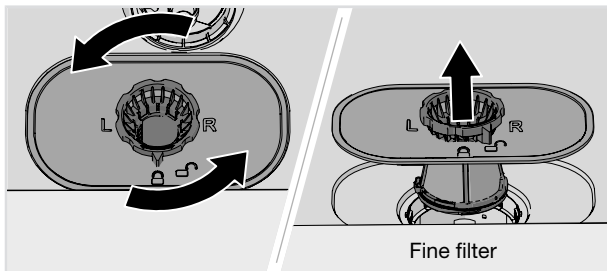

1. Turn the locking ring anticlockwise and lift the fine filter straight up.
2. Clean the fine filter.
3. Refit the fine filter and turn the locking ring clockwise to its stop position. Check that the edges seal properly.

Remember to refit the coarse filter!

NOTE!

Dishwashing results may be affected if the coarse and fine filters are incorrectly fitted. The dishwasher must not be used without the filters in place!

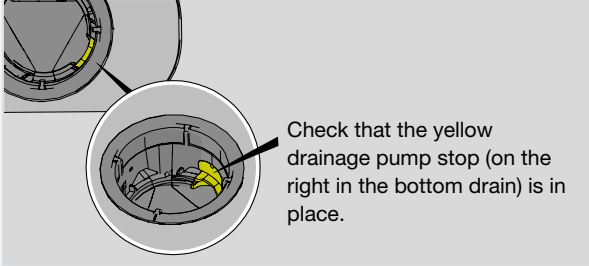

Cleaning the spray arms

Holes and bearings can sometimes become blocked. Remove any debris using a pin or the like. The spray arms also have holes underneath.

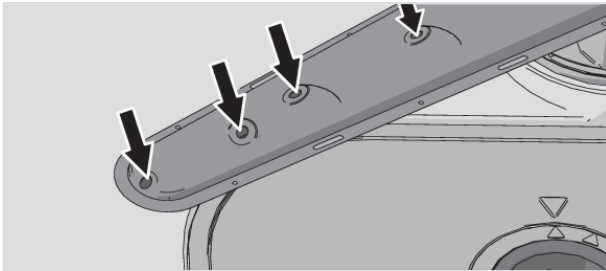

To facilitate cleaning you can remove the spray arms. Remember to fit them firmly back into place afterwards.

Top spray arm

- Push up on the top spray arm while turning it anticlockwise to release it.

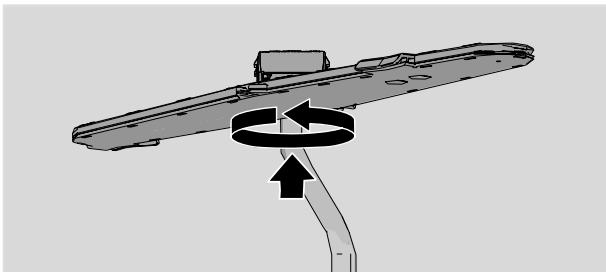

Care and cleaning

Upper spray arm

- Pull out the upper basket.
- Unscrew the spray arm bearings anticlockwise to remove the spray arm from the upper basket.

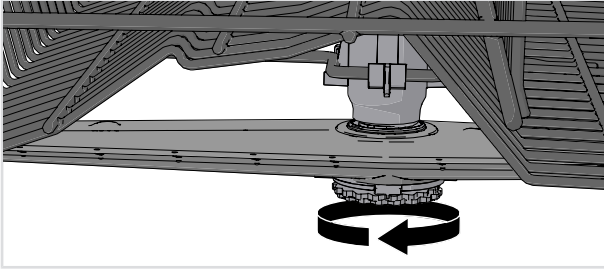

Lower spray arm

- Pull the lower spray arm straight up to release it.

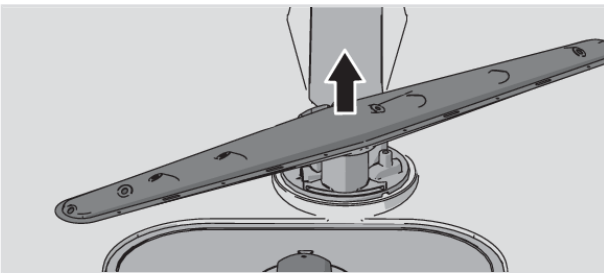

Clean the outside of the dishwasher

Door and door seal

Open the door. Clean the sides of the door and the door seal regularly with a slightly damp cloth. Clean the door seal at the lower front edge of the dishwasher with a washing-up brush.

Control panel

Keep the control panel clean. If necessary, wipe it with a dry or slightly damp cloth. Never use cleaning products – they may scratch the surface.

Run Self-cleaning

Dishwasher tub

The dishwasher tub is made of stainless steel and is kept clean through normal use (when used regularly).

If you have hard water, limescale deposits may build up in the dishwasher. If this happens, run the Self-cleaning program with two tablespoons of citric acid in the dishwasher's manual detergent compartment (with no dishes in the machine). Special dishwasher cleaners are also available on the market.

Remove blockages

Unblocking the drainage pump

If the dishwasher still contains water after the program has finished, something may be blocking the drainage pump, which results in the error message Water outlet fault or BLDC drain pump fault.

1. Turn off the machine using ⏻ and remove the plug from the wall socket.
2. Remove the coarse filter and the fine filter.
3. Scoop out the water from the dishwasher tub.
4. In order to inspect the drainage pump, remove the yellow drainage pump stop on the right in the bottom drain. (Use a pair of pliers if necessary.)
5. Turn the pump wheel located behind the drainage pump stop by hand. Carefully remove any sharp items, such as glass.
6. Refit the drainage pump stop along with the fine and coarse filters.
7. Plug the machine in again.

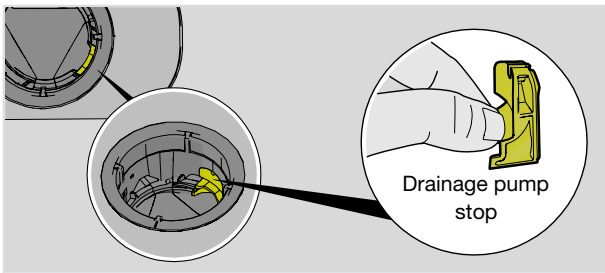

NOTE!

Do not forget to refit the drainage pump stop.

Unblocking the inlet hose filter

If the water supply contains small particles, the outer filter on the inlet hose may become blocked, which results in the Water inlet fault error message.

1. Turn off the machine using ⏻ and remove the plug from the wall socket.
2. Turn off the water tap.
3. Unscrew the inlet hose.
4. Carefully remove the outer filter from the inlet hose and clean it.
5. Refit the filter and check that the gasket is correctly positioned.
6. Screw the inlet hose firmly into place.

Care and cleaning

7. Plug the machine into the wall socket and turn on the water tap. Allow the pressure to settle for a while and check that the connection is watertight.

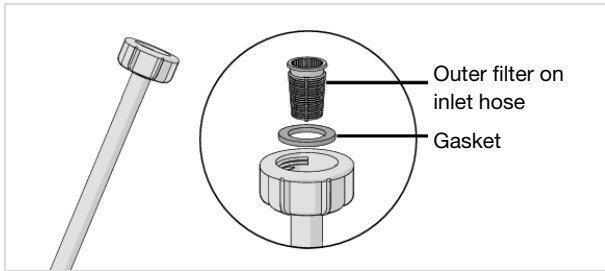

Winter storage/Transport

Store the dishwasher above freezing temperature and avoid long transport distances in very cold weather. Transport the dishwasher upright or laying on its back.

Before transporting a used dishwasher, or before prolonged storage, water must first be removed from the machine.

Error messages		Action
F10	Overfilling water 1	Unblocking the drainage pump. See the chapter <i>Care and cleaning</i> . If the problem persists, contact your nearest service centre.
F11	Water outlet fault	See "Water remains in the dishwasher" under "Problem" in the table below. If the problem persists, contact your nearest service centre.
F12	Water inlet fault 1	Check that the water tap is on. Check that the outer filter on the inlet hose is not blocked. See <i>Unblocking the inlet hose filter</i> in the chapter <i>Care and cleaning</i> . If the problem persists, contact your nearest service centre.
F40	Inlet valve leakage	Turn off the water tap and contact your nearest service centre.
F41	Heater fault 1	Turn off the water tap. Remove the plug from the wall socket and contact your nearest service centre.
F46	Heater fault 2	Turn off the water tap. Remove the plug from the wall socket and contact your nearest service centre.
F52	Water level fault	Clean the coarse and fine filters. Check that the outer filter on the inlet hose is not blocked. If the problem persists, contact your nearest service centre.
F54	Overfilling water 2	Turn off the water tap and contact your nearest service centre. To avoid water leakage outside the dishwasher, do not remove the plug from the wall socket until the water tap on the supply line has been turned off!
F56	Circulation pump fault	Run a program. If the problem persists, contact your nearest service centre.
F67	Water inlet fault 2	Check that the water tap is on. Check that the outer filter on the inlet hose is not blocked. See <i>Unblocking the inlet hose filter</i> in the chapter <i>Care and cleaning</i> . If the problem persists, contact your nearest service centre.
F68	BLDC drain pump fault	See "Water remains in the dishwasher" under "Problem" in the table below. If the problem persists, contact your nearest service centre.
F70	Lock fault	Close the dishwasher door. If the problem persists, contact your nearest service centre.
F76	Sani lock fault	Contact your nearest service centre.

Press any button to clear the error message.

Troubleshooting

General

Problem	Possible causes	Action
The control panel does not react when pressed.	You have pressed the control panel too soon after opening the door.	Wait a moment then try again.
	Lock is activated.	See the chapter <i>Safety instructions</i> .
	Dirt on the control panel.	Clean with a dry or slightly damp cloth.
	The control panel requires calibration.	Turn off the water tap. Remove the plug from the wall socket and wait for 60 seconds. Then plug the appliance back into the wall socket and turn on the water tap.
Cannot close door.	The baskets are not correctly positioned.	Check that the baskets are correctly positioned horizontally.
		Check that the dishes are not blocking the baskets from sliding properly into place.
	The door lock does not click into place and lock.	Open the door. Press and hold I and ●● until "Auto door open recovery" is shown on the display, wait until the message disappears. Close the door, then check that the door lock is working.
The door cannot be opened.	Lock is activated.	See the chapter <i>Safety instructions</i> .
	To prevent the risk of burn injuries, the door cannot be opened while the dishwasher temperature exceeds 65 °C.	Wait until the dishwasher indicates that the program has ended and the dishes have cooled before unloading the dishwasher.
	The dishwasher is/has been powerless while Sani lock or Lock is/has been activated.	See <i>Power failure</i> in the chapter <i>Using the dishwasher</i> or contact your nearest service centre.

Problem	Possible causes	Action
The dishwasher does not start.	▷ □ has not been pressed.	Press ▷ □ until the display shows "Program started, close door".
	The door is not properly closed.	Check.
	Salt compartment empty.	Top up with salt. See the chapter <i>Care and cleaning</i> .
	The dishwasher has been opened while a program is in progress.	Close the door and wait. After a while, the dishwasher continues the program.
	The door lock has not clicked into place and locked.	Open the door. Press and hold I and ●● until "Auto door open recovery" is shown on the display, wait until the message disappears. Close the door, then check that the door lock is working.
	The plug is not plugged into the wall socket.	Check.
	A fuse/circuit breaker has been tripped.	Check.

Troubleshooting

Problem	Possible causes	Action
The dishes are not clean.	The spray arms are not rotating freely.	Check that the dishes are not blocking the spray arms.
	Spray arm holes or bearings blocked.	Clean the spray arms. See the chapter <i>Care and cleaning</i> .
	Unsuitable dishwashing program.	Select a program with a high temperature to dissolve grease on very dirty dishes, such as Intensive.
	Incorrect detergent dosage.	Dose according to water hardness. Far too much or far too little detergent results in poorer dishwashing results.
	Old detergent. Detergent is a perishable product.	Avoid large packages.
	Auto dose is activated, but dishwasher detergent gel is not dispensed.	To check that detergent is dispensed, press and hold > and ▷ □ for five seconds. The symbol ● will flash on the display. Now check whether any dishwasher detergent gel has been dispensed.
	Dishes loaded incorrectly.	Do not cover porcelain with large bowls or the like. Avoid placing very tall glasses in the corners of the baskets. See the chapter <i>Loading the dishwasher</i> .
	Glasses and cups have toppled over during the program.	Place dishes to sit steady.
	The filters are clogged.	Clean the coarse and fine filters.
	The filters are not fitted correctly.	Check that the filters are fitted correctly. See the chapter <i>Care and cleaning</i> .
Drainage pump stop missing.	Check that the yellow drainage pump stop (on the right in the bottom drain) is in place. See the chapter <i>Care and cleaning</i> .	

Problem	Possible causes	Action
Spots on stainless steel or silver.	Some foodstuffs, such as mustard, mayonnaise, lemon, vinegar, salt and dressings, can cause spots on stainless steel if left for too long.	Rinse off these types of foodstuffs if not starting the dishwasher immediately. Use the Rinse and hold program.
	All stainless steel can cause spots on silver if they come into contact during dishwashing. Aluminium can also cause spots on dishes.	In order to avoid marks and tarnishing, separate dishes made from different metals, such as silver, stainless steel and aluminium.
Spots or films on the dishes.	Incorrect rinse aid dosage setting.	See the chapter <i>Settings</i> .
	The setting TAB is activated and all-in-one detergent with insufficient drying effect is being used.	Switch all-in-one detergents or deactivate the setting TAB and top up with salt and separate rinse aid. See Rinse aid in the chapter <i>Settings</i> .
	Incorrect water softener setting.	See Water hardness in the chapter <i>Settings</i> .
	The water softener is leaking salt.	Check that the salt compartment lid is tightened clockwise to its end position. Otherwise contact your nearest service centre.
	Too high temperature and/or too much detergent can cause etching on crystal. Unfortunately, this cannot be repaired, only prevented.	Wash crystal at a low temperature and with a conservative amount of detergent. Contact the detergent manufacturer.
The dishes have a sticky white/blue film.	Rinse aid dosage setting too high.	Reduce the dosage. See the chapter <i>Settings</i> . If you have very soft water, you may want to dilute the rinse aid 50:50 with water.
Spots left after washing.	Lipstick and tea/coffee stains can be difficult to remove.	Use a detergent with a bleaching agent.
		Dishwasher detergent gel is being used. If necessary, on such occasions dishwasher detergent powder or all-in-one detergent with bleaching agent can be added to the manual detergent compartment (when Auto dose is activated). See <i>Add detergent</i> .

Troubleshooting

Problem	Possible causes	Action
Detergent residue in the detergent compartment after dishwashing.	The detergent compartment was damp when adding detergent.	The detergent compartment must be dry when adding detergent.
	The detergent compartment has been blocked.	Check that the dishes are not preventing the detergent compartment from opening.
Rattling sound when dishwashing.	The dishes are not correctly placed or the spray arms are not rotating freely.	Check that the dishes are placed securely. Spin the spray arms to make sure they can rotate.
1 minute is shown for a longer period in the display.	The program is taking longer than estimated.	No action. The program time is stored and next time the program is run the corrected time will be displayed.
"Block start when softener is empty" is shown on the display.	Salt compartment empty.	Top up with salt. See the chapter <i>Care and cleaning</i> . (The setting to prevent a dishwashing program from starting when the salt compartment is empty can be deactivated. See the <i>Settings</i> chapter.)
Water remains in the dishwasher.	The filters are clogged.	Clean the coarse and fine filters.
	The filters are not fitted correctly.	Check that the filters are fitted correctly. See the chapter <i>Care and cleaning</i> .
	Debris in the drainage pump.	Clean the drainage pump. See the chapter <i>Care and cleaning</i> .
	Drainage pump stop missing.	Check that the yellow drainage pump stop (on the right in the bottom drain) is in place. See the chapter <i>Care and cleaning</i> .
	Kink in drainage hose.	Check that the hose is free from kinks and sharp bends.
	Blocked drainage hose.	Disconnect the drainage hose where it connects to the sink unit's water trap. Check that no debris has fastened and that the connection has an inner diameter of at least 14 mm.

Problem	Possible causes	Action
Bad odour in dishwasher.	Dirt around the seals and in corners.	Clean with washing-up brush and low foaming cleaner.
	Low temperature programs have been selected for a prolonged period.	Run a program with a high temperature once or twice a month. Or run a self-cleaning program. See Self-cleaning in the chapter <i>Using the dishwasher</i> .
Grease deposits in the dishwasher.	Low temperature programs have been selected for a prolonged period.	Select a program with a high temperature to dissolve grease on very dirty dishes, such as Intensive. Or run a self-cleaning program once or twice a month. See Self-cleaning in the chapter <i>Using the dishwasher</i> .
The dishes are not dry enough.	The Automatic door opening option is not activated.	Activate the Automatic door opening option.
	The dishwasher is not fully loaded.	Fully load the dishwasher.
	Rinse aid needs topping up or dosage is set too low.	Top up with rinse aid or increase the rinse aid dosage setting.
	The setting TAB is activated and all-in-one detergent with insufficient drying effect is being used.	Switch all-in-one detergents or deactivate the setting TAB and top up with salt and separate rinse aid. See Rinse aid in the chapter <i>Settings</i> .

Troubleshooting

WiFi

Problem	Possible causes	Action
The dishwasher's network symbol  does not appear on the display.	The dishwasher is not connected to your wireless network.	Connect the dishwasher to your wireless network. See the chapter <i>ASKO Connect Pro & ConnectLife</i> .
	WiFi connection is deactivated.	Activate WiFi connection. See WiFi connection <i>On/Off</i> in the chapter <i>Settings</i> .
Connection setup failed	The dishwasher cannot access your wireless network. Or the router is not connected to the internet.	Check that the router is connected to the internet.
		Make sure your wireless network is using 2.4 GHz and is visible. Try moving the router closer to the dishwasher if the signal is too weak.
		See also troubleshooting at www.connectlife.io . If the problem persists, contact your nearest service centre.
Add device failed	Your smartphone/tablet is not connected to your wireless network. Or the router is not connected to the internet.	Check that the router is connected to the internet.
		Check that your smartphone/tablet is connected to your wireless network.
		See also troubleshooting at www.connectlife.io . If the problem persists, contact your nearest service centre.
The dishwasher is shown as disconnected in the <i>ConnectLife app</i> .	WiFi connection is deactivated.	Activate WiFi connection. See WiFi connection <i>On/Off</i> in the chapter <i>Settings</i> .
		See also troubleshooting at www.connectlife.io . If the problem persists, contact your nearest service centre.
Software update failed.	The network connection was lost or the dishwasher lost power due to a power failure.	Make sure that the power supply is not interrupted and that the network connection is stable before trying again. If the problem persists, contact your nearest service centre.

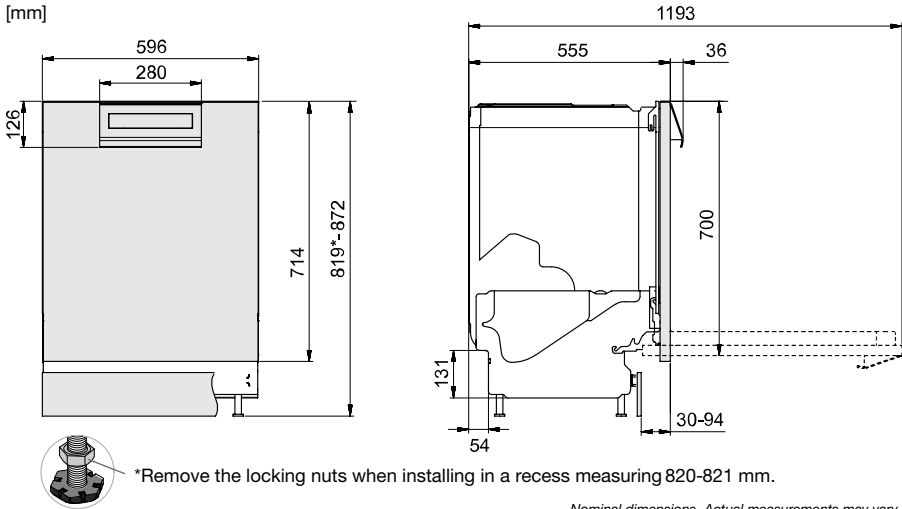

Safety instructions

- Connections to electricity, water and drainage must be performed by a qualified professional.
- Always follow applicable regulations for water, drainage and electricity.
- Take care during installation! Wear protective gloves! There must always be two people!
- Place a drip tray on the floor beneath the dishwasher to prevent damage from any water leaks.
- Before screwing the dishwasher into place, test the dishwasher by running the Rinse and hold program. Check that the dishwasher fills with water and drains. Check also that none of the connections leak.

WARNING!

The ventilation opening in the lower part of the door must not be blocked by a rug, carpet or similar furnishing.

WARNING!

Turn off the water supply when installing the dishwasher!

The plug must be disconnected or power to the socket turned off while the work is carried out!

Installation

Transport protection for the door

Do not forget to remove the transport protection for the door when unpacking the dishwasher.

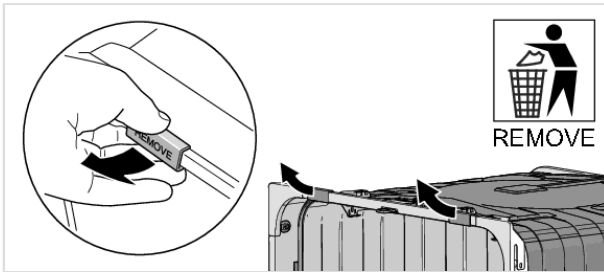

Placing the dishwasher

The dishwasher is intended to be built-in under a worktop. The built-in measurements are shown in the illustration. Make sure that the cable and hose hole's edges are even and will not damage the drainage and inlet hoses or the power cable.

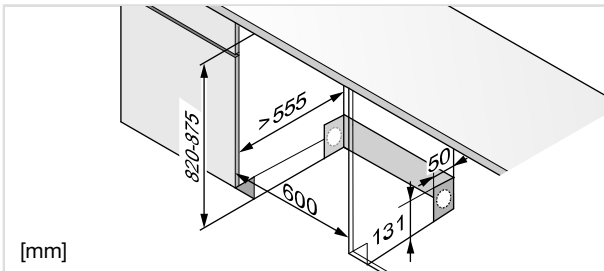

If the dishwasher is built-in the surrounding furnishings must be resistant to any condensation from the dishwasher.

Accessory

Buy an accessory kit for freestanding installation (two side panels, a worktop and two anti-tip brackets). If the dishwasher is placed so that one of the sides is visible, side panels must be fitted. If the dishwasher is completely freestanding, both side panels, a worktop and anti-tip brackets must be fitted. Accessories can be purchased from where you bought the dishwasher.

Affix the protective film

Mount the protective film beneath the worktop and up around the edge. The function of the protective film is to protect the worktop from moisture. (The protective film is in the enclosed plastic bag.)

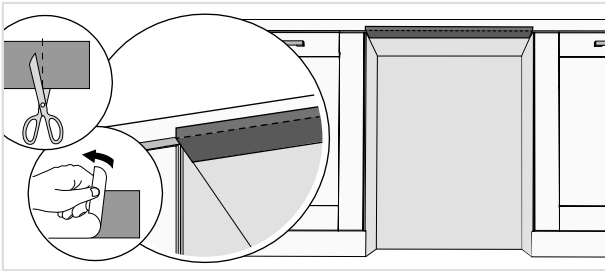

NOTE!

The surface to which the protective film is affixed must be clean and dry.

Adjust the height and slide the dishwasher into place

1. Start by measuring the height from the floor to the bottom edge of the worktop.
2. Measure the height from the floor to the top edge of the dishwasher.
3. Lean the dishwasher forwards a little and adjust the rear foot with the screw at the front of the dishwasher. Turn clockwise to lower or anticlockwise to raise.

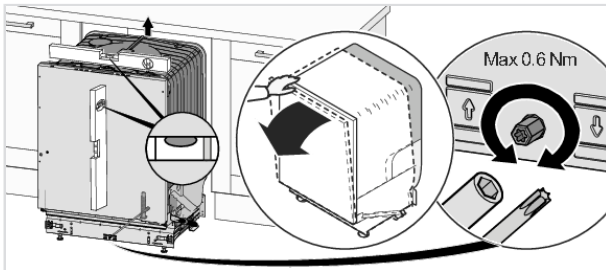

4. Adjust the front feet by turning them clockwise to raise and anticlockwise to lower the dishwasher.

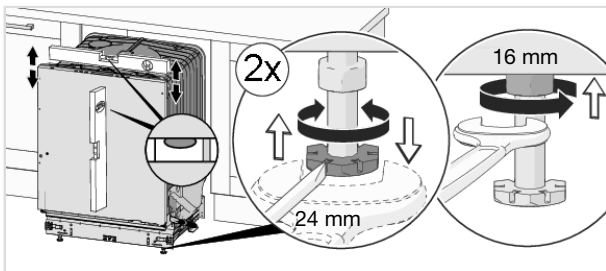

5. Check that there is an air gap of at least 3 mm between the underside of the worktop and the top edge of the dishwasher.
6. Slide the dishwasher into place.
 - Pull the supply and drainage hoses and the power cable when sliding the dishwasher into place.

Installation

- Check that the drainage hose has no kinks or sharp bends. Also check that there is nothing that can damage the hoses.

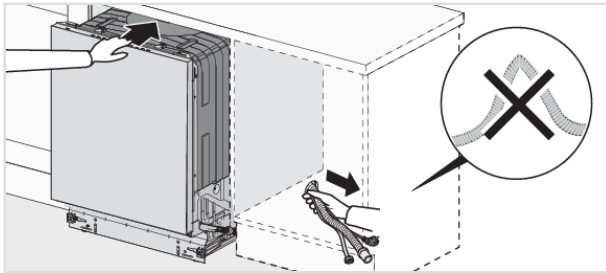

- Check that the machine is installed such that the door opens freely, otherwise door lock functionality may be disrupted.

7. Make any final adjustments to the feet and tighten the lock nuts on the front feet.

Drainage connection

This dishwasher is suitable for installing in a raised recess (to attain an ergonomic working height). This means that the dishwasher can be placed so that the drainage hose runs to a lower level than the bottom of the dishwasher, such as by routing it directly to a floor drain.

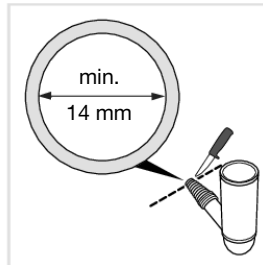
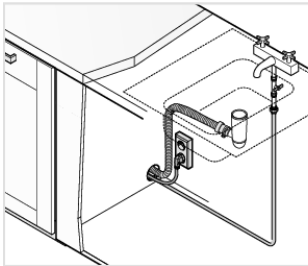

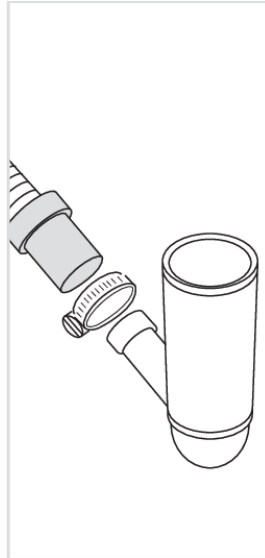
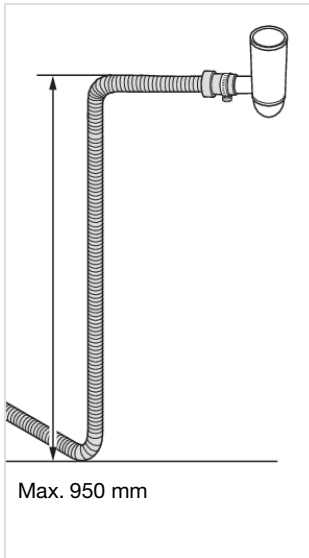

The drainage hose can also be connected to a connection nipple on the sink unit's water trap. The connection nipple must have an internal diameter of at least 14 mm.

The drainage hose may be extended by a maximum of 2.5 m (the total length of the drainage hose must not exceed 4.5 m). Any joints and connecting pipes must have an internal diameter of at least 14 mm.

No part of the drainage hose may be more than 950 mm above the bottom of the dishwasher.

Attach the drainage hose with a hose clamp. Ensure that the drainage hose has no kinks.

Connection to water supply

The dishwasher can be connected to hot (max. 70 °C) or cold water. The dishwasher adjusts automatically to the connected water in order to achieve the best dishwashing result. To achieve optimal short dishwashing times, the dishwasher should be connected to hot water.

Use only the inlet hose supplied with the dishwasher. Do not re-use old or other spare hoses.

The supply pipe must be fitted with a water tap (stopcock). The water tap must be easily accessible, so that the water can be shut off if the dishwasher has to be moved.

The water pressure must be between 0,1–1,0 MPa. To achieve optimal short dishwashing time, the water pressure must be at least 0,2 MPa.

Once the installation is complete, turn on the water tap and allow the pressure to settle for a while. Check that all connections are watertight.

Installation

Install the double check valve (UK only)

Install the double check valve between the water tap and the inlet hose. (Found in the enclosed plastic bag.)

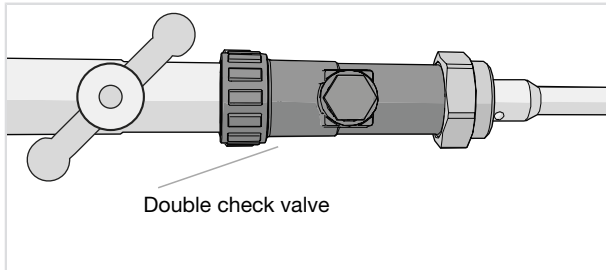

Electrical connection

Information about the electrical connection can be found on the serial number plate. This specification must match the electricity supply.

The dishwasher must be connected to an earthed socket.

The electric wall socket must be placed outside of the installation area to be easily accessible after installing the dishwasher. Do not use an extension cord!

The dishwasher must be connected to residual current devices as per the relevant safety regulations.

Screwing the dishwasher into place

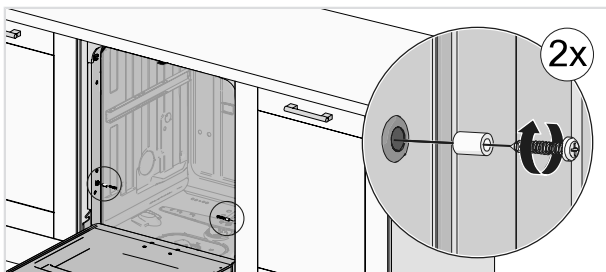
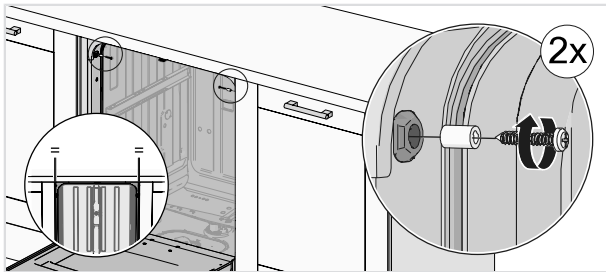

After fastening the machine, check that the front feet still touch the floor.

Dishwasher toe kick

The dishwasher is supplied with a toe kick.

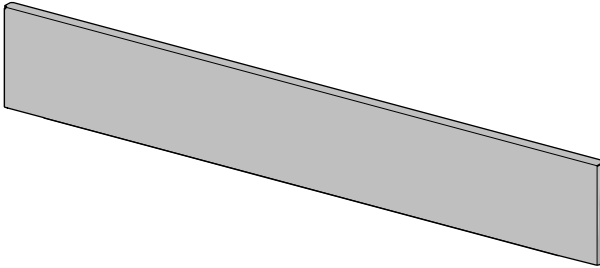

Fit the sound insulation

(only certain models)

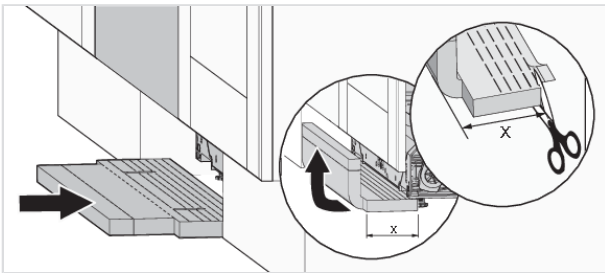

Fit the toe kick

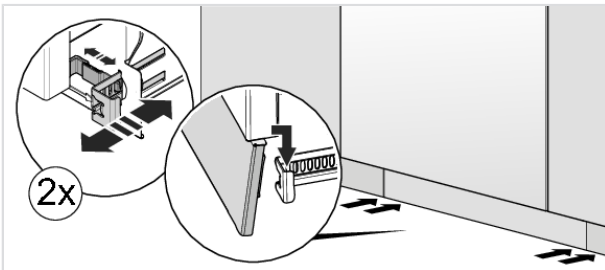

Information about your product

There is a QR code on the serial number plate. Scan the code to view information about your product.

Contact your nearest service centre

Read the chapter *Troubleshooting* before contacting the service centre. If you have encountered a problem that you cannot resolve, please contact your nearest service centre for professional help, see www.asko.com. Our website also has information about spare part availability and what you can repair yourself.

When making contact, provide the details on the serial number plate. Include the article number (1) and the serial number (2).

Please note that non-professional repairs may risk user safety and affect the warranty.



Spare parts

The following spare parts are available for at least seven years after the model is no longer manufactured: Motor, circulation and drainage pump, heating element, pipes and hoses, valves, filters and aquastops, door attachment components, circuit boards, electronic display, pressure sensor, thermostats and sensors, software including restore programs.

The following spare parts are available for at least ten years after the model is no longer manufactured: Door hinges and seals, other seals, spray arms, drain filters, wire baskets and plastic accessories such as baskets and lids.

Number of cycles

Press and hold > and ●●● for 3 seconds to show Number of cycles on the display.

Technical data

Height:	819-872 mm
Width:	596 mm
Depth:	555 mm
Weight:	50 kg ¹⁾
Number of standard place settings:	13 ²⁾
Water pressure:	0,1–1,0 MPa
Electrical connection:	See the serial number plate
Rated power:	See the serial number plate
Frequency band, WiFi module:	2.4 GHz
Maximum transmit power, WiFi module:	≤ 1 W

¹⁾ Weight can vary due to different specifications.

²⁾ In accordance with the EN 60436 standard.

Information for consumers

Information about your appliance can be found at <https://global.asko.com/energy-label>. You can also find information in the EU Product Registration database for Energy Labelling, EPREL. Scan the QR code on the energy label supplied with the dishwasher (or go to <https://eprel.ec.europa.eu> and search for the model name).

This appliance contains a light source/light sources of energy efficiency class D. Light sources are available as spare parts and can be replaced, without damage to the dishwasher, by your nearest service centre or a similarly qualified professional.

Information for test institute

Information about this product can be found in the European Product Database for Energy Labelling, EPREL, and can also be ordered by e-mail dishwashers@appliance-development.com.

The request should include the details on the serial number plate. Include the article number (1), the serial number (2) and the model name (3).

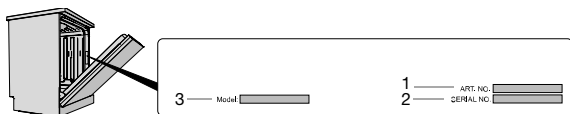

Declaration of conformity

The company declares that the device with the function Connectlife complies with the essential requirements and other relevant provisions of Directive 2014/53/EU. The detailed Declaration of Conformity can be found at the web address <https://aid.connectlife.io> on the page of your device among the additional documents.

ASKO
PROFESSIONAL

WWW.ASKO.COM



931506-a3

We reserve the right to make changes.