

▶ BEB351010M  
BEB351010W

EN User Manual  
Oven

# USER MANUAL



**AEG**

# CONTENTS

1. SAFETY INFORMATION.....	2
2. SAFETY INSTRUCTIONS.....	4
3. PRODUCT DESCRIPTION.....	7
4. CONTROL PANEL.....	7
5. BEFORE FIRST USE.....	8
6. DAILY USE.....	9
7. CLOCK FUNCTIONS.....	11
8. USING THE ACCESSORIES.....	12
9. ADDITIONAL FUNCTIONS.....	13
10. HINTS AND TIPS.....	14
11. CARE AND CLEANING.....	29
12. TROUBLESHOOTING.....	32
13. ENERGY EFFICIENCY.....	33

## FOR PERFECT RESULTS

Thank you for choosing this AEG product. We have created it to give you impeccable performance for many years, with innovative technologies that help make life simpler – features you might not find on ordinary appliances. Please spend a few minutes reading to get the very best from it.

Visit our website to:



Get usage advice, brochures, trouble shooter, service and repair information:  
[www.aeg.com/support](http://www.aeg.com/support)



Register your product for better service:  
[www.registeraeg.com](http://www.registeraeg.com)



Buy Accessories, Consumables and Original spare parts for your appliance:  
[www.aeg.com/shop](http://www.aeg.com/shop)

## CUSTOMER CARE AND SERVICE

Always use original spare parts.

When contacting our Authorised Service Centre, ensure that you have the following data available: Model, PNC, Serial Number.

The information can be found on the rating plate.

 Warning / Caution-Safety information

 General information and tips

 Environmental information

Subject to change without notice.

### 1. SAFETY INFORMATION

Before the installation and use of the appliance, carefully read the supplied instructions. The manufacturer is not

responsible for any injuries or damage that are the result of incorrect installation or usage. Always keep the instructions in a safe and accessible location for future reference.

### 1.1 Children and vulnerable people safety

- This appliance can be used by children aged from 8 years and above and persons with reduced physical, sensory or mental capabilities or lack of experience and knowledge if they have been given supervision or instruction concerning the use of the appliance in a safe way and understand the hazards involved. Children of less than 8 years of age and persons with very extensive and complex disabilities shall be kept away from the appliance unless continuously supervised.
- Do not let children play with the appliance.
- Keep all packaging away from children and dispose of it appropriately.
- **WARNING:** Keep children and pets away from the appliance when it operates or when it cools down. Accessible parts become hot during use.
- If the appliance has a child safety device, it should be activated.
- Children shall not carry out cleaning and user maintenance of the appliance without supervision.

### 1.2 General Safety

- Only a qualified person must install this appliance and replace the cable.
- **WARNING:** The appliance and its accessible parts become hot during use. Care should be taken to avoid touching heating elements.
- Always use oven gloves to remove or put in accessories or ovenware.
- Before carrying out any maintenance, disconnect the appliance from the power supply.

- **WARNING:** Ensure that the appliance is switched off before replacing the lamp to avoid the possibility of electric shock.
- Do not use the appliance before installing it in the built-in structure.
- Do not use a steam cleaner to clean the appliance.
- Do not use harsh abrasive cleaners or sharp metal scrapers to clean the glass door since they can scratch the surface, which may result in shattering of the glass.
- If the mains power supply cable is damaged, it must be replaced by the manufacturer, its Authorised Service Centre or similarly qualified persons to avoid an electrical hazard.
- To remove the shelf supports first pull the front of the shelf support and then the rear end away from the side walls. Install the shelf supports in the opposite sequence.

## 2. SAFETY INSTRUCTIONS

### 2.1 Installation



**WARNING!**  
Only a qualified person must install this appliance.

- Remove all the packaging.
- Do not install or use a damaged appliance.
- Follow the installation instructions supplied with the appliance.
- Always take care when moving the appliance as it is heavy. Always use safety gloves and enclosed footwear.
- Do not pull the appliance by the handle.
- Install the appliance in a safe and suitable place that meets installation requirements.
- Keep the minimum distance from other appliances and units.
- Before mounting the appliance, check if the oven door opens without restraint.
- The appliance is equipped with an electric cooling system. It must be

operated with the electric power supply.

- The built-in unit must meet the stability requirements of DIN 68930.

Cabinet minimum height (Cabinet under the worktop minimum height)	600 (600) mm
Cabinet width	550 mm
Cabinet depth	605 (580) mm
Height of the front of the appliance	594 mm
Height of the back of the appliance	576 mm
Width of the front of the appliance	549 mm
Width of the back of the appliance	548 mm

Depth of the appliance	567 mm
Built in depth of the appliance	546 mm
Depth with open door	1017 mm
Ventilation opening minimum size. Opening placed on the bottom rear side	550 x 20 mm
Mains supply cable length. Cable is placed in the right corner of the back side	1500 mm
Mounting screws	4 x 12 mm

## 2.2 Electrical connection



**WARNING!**  
Risk of fire and electric shock.

- All electrical connections should be made by a qualified electrician.
- The appliance must be earthed.
- Make sure that the parameters on the rating plate are compatible with the electrical ratings of the mains power supply.
- Always use a correctly installed shockproof socket.
- Do not use multi-plug adapters and extension cables.
- Make sure not to cause damage to the mains plug and to the mains cable. Should the mains cable need to be replaced, this must be carried out by our Authorised Service Centre.
- Do not let mains cables touch or come near the appliance door or the niche below the appliance, especially when it operates or the door is hot.
- The shock protection of live and insulated parts must be fastened in such a way that it cannot be removed without tools.
- Connect the mains plug to the mains socket only at the end of the installation. Make sure that there is access to the mains plug after the installation.

- If the mains socket is loose, do not connect the mains plug.
- Do not pull the mains cable to disconnect the appliance. Always pull the mains plug.
- Use only correct isolation devices: line protecting cut-outs, fuses (screw type fuses removed from the holder), earth leakage trips and contactors.
- The electrical installation must have an isolation device which lets you disconnect the appliance from the mains at all poles. The isolation device must have a contact opening width of minimum 3 mm.
- This appliance is supplied with a main plug and a main cable.

## 2.3 Use



**WARNING!**  
Risk of injury, burns and electric shock or explosion.

- This appliance is for household use only.
- Do not change the specification of this appliance.
- Make sure that the ventilation openings are not blocked.
- Do not let the appliance stay unattended during operation.
- Deactivate the appliance after each use.
- Be careful when you open the appliance door while the appliance is in operation. Hot air can release.
- Do not operate the appliance with wet hands or when it has contact with water.
- Do not apply pressure on the open door.
- Do not use the appliance as a work surface or as a storage surface.
- Open the appliance door carefully. The use of ingredients with alcohol can cause a mixture of alcohol and air.
- Do not let sparks or open flames to come in contact with the appliance when you open the door.
- Do not put flammable products or items that are wet with flammable products in, near or on the appliance.



**WARNING!**  
Risk of damage to the appliance.

- To prevent damage or discoloration to the enamel:
  - do not put ovenware or other objects in the appliance directly on the bottom.
  - do not put aluminium foil directly on the bottom of cavity of the appliance.
  - do not put water directly into the hot appliance.
  - do not keep moist dishes and food in the appliance after you finish the cooking.
  - be careful when you remove or install the accessories.
- Discoloration of the enamel or stainless steel has no effect on the performance of the appliance.
- Use a deep pan for moist cakes. Fruit juices cause stains that can be permanent.
- This appliance is for cooking purposes only. It must not be used for other purposes, for example room heating.
- Always cook with the oven door closed.
- If the appliance is installed behind a furniture panel (e.g. a door) make sure the door is never closed when the appliance operates. Heat and moisture can build up behind a closed furniture panel and cause subsequent damage to the appliance, the housing unit or the floor. Do not close the furniture panel until the appliance has cooled down completely after use.

## 2.4 Care and cleaning



**WARNING!**  
Risk of injury, fire, or damage to the appliance.

- Before maintenance, deactivate the appliance and disconnect the mains plug from the mains socket.
- Make sure the appliance is cold. There is the risk that the glass panels can break.

- Replace immediately the door glass panels when they are damaged. Contact the Authorised Service Centre.
- Clean regularly the appliance to prevent the deterioration of the surface material.
- Clean the appliance with a moist soft cloth. Use only neutral detergents. Do not use abrasive products, abrasive cleaning pads, solvents or metal objects.
- If you use an oven spray, follow the safety instructions on its packaging.

## 2.5 Internal lighting



**WARNING!**  
Risk of electric shock.

- Concerning the lamp(s) inside this product and spare part lamps sold separately: These lamps are intended to withstand extreme physical conditions in household appliances, such as temperature, vibration, humidity, or are intended to signal information about the operational status of the appliance. They are not intended to be used in other applications and are not suitable for household room illumination.
- Use only lamps with the same specifications.

## 2.6 Service

- To repair the appliance contact the Authorised Service Centre.
- Use original spare parts only.

## 2.7 Disposal



**WARNING!**  
Risk of injury or suffocation.

- Disconnect the appliance from the mains supply.
- Cut off the mains electrical cable close to the appliance and dispose of it.
- Remove the door catch to prevent children or pets from becoming trapped in the appliance.

## 3. PRODUCT DESCRIPTION

### 3.1 General overview

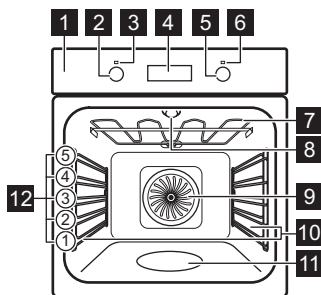

- 1** Control panel
- 2** Knob for the heating functions
- 3** Power lamp / symbol
- 4** Display
- 5** Control knob (for the temperature)
- 6** Temperature indicator / symbol
- 7** Heating element
- 8** Lamp
- 9** Fan
- 10** Shelf support, removable
- 11** Cavity embossment - Aqua cleaning container
- 12** Shelf positions

### 3.2 Accessories

#### Wire shelf

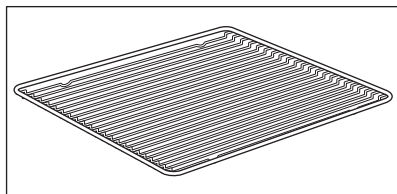

For cookware, cake tins, roasts.

#### Baking tray

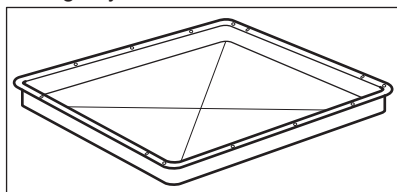

For cakes and biscuits.

#### Grill- / Roasting pan

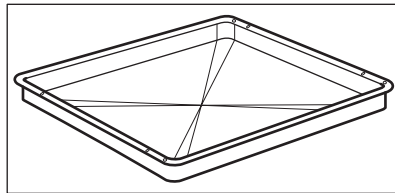

To bake and roast or as a pan to collect fat.

## 4. CONTROL PANEL

### 4.1 Retractable knobs

To use the appliance press the knob.  
The knob comes out.

## 4.2 Sensor fields / Buttons

—	To set the time.
⌚	To set a clock function.
+	To set the time.

## 4.3 Display

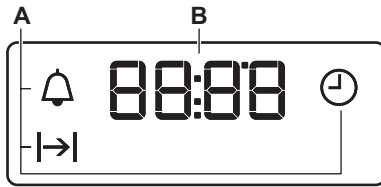





- A. Clock functions  
B. Timer

# 5. BEFORE FIRST USE

 **WARNING!**  
Refer to Safety chapters.

## 5.1 Before first use

The oven can emit an odour and smoke during preheating. Make sure that the room is ventilated.

 Step 1	 Step 2	 Step 3
Set the clock	Clean the oven	Preheat the empty oven
1. Press: ⌚. 2. +, — - press to set the hour. Press: ⌚. 3. +, — - press to set the minutes. Press: ⌚.	1. Remove all accessories and removable shelf supports from the oven. 2. Clean the oven and the accessories with a soft cloth, warm water and a mild detergent.	1. Set the maximum temperature for the function:  . Time: 1 h. 2. Set the maximum temperature for the function:  . Time: 15 min.
Turn off the oven and wait until it is cold. Place the accessories and the removable shelf supports in the oven.		



## 6. DAILY USE

 **WARNING!**  
Refer to Safety chapters.

### 6.1 How to set: Heating function

Step 1 Turn the knob for the heating functions to select a heating function.

Step 2 Turn the control knob to select the temperature.

Step 3 When the cooking ends, turn the knobs to the off position to turn off the oven.

### 6.2 Setting the function: True Fan Cooking PLUS

 **WARNING!**  
Risk of burns and damage to the appliance.

Step 1 Make sure that the oven is cold.

Step 2 Fill the cavity embossment with tap water.

 The maximum capacity of the cavity embossment is 250 ml. Do not refill the cavity embossment during cooking or when the oven is hot.

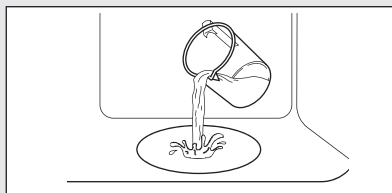

Step 3 Set the function: .

Step 4 Turn the control knob for the temperature to set temperature.

Step 5 Preheat the empty oven for 10 min to create humidity.







Step 6 Put food in the oven.  
Refer to "Hints and tips" chapter. Do not open the oven door during cooking.



Step 7 Turn the knob for the heating functions to the off position to turn off the oven.

Step 8 After the function ends, carefully open the door. Released humidity can cause burns.

Step 9 Make sure that the oven is cold. Remove the remaining water from the cavity embossment.

## 6.3 Heating functions

Heating function	Application
 Off position	The oven is off.
 Light	To turn on the lamp.
 True Fan Cooking	<p>To bake on up to three shelf positions at the same time and to dry food.</p> <p>Set the temperature 20 - 40 °C lower than for Conventional Cooking.</p>
 Pizza Function	To bake pizza. To make intensive browning and a crispy bottom.
 Conventional Cooking	To bake and roast food on one shelf position.
 Moist Baking	<p>This function is designed to save energy during cooking. When you use this function, the temperature in the cavity may differ from the set temperature. The heating power may be reduced. For more information refer to "Daily Use" chapter, Notes on: Moist Baking.</p>
 Defrost	To defrost food (vegetables and fruit). The defrosting time depends on the amount and size of the frozen food.

Heating function	Application
 True Fan Cooking / True Fan Cooking PLUS / Aqua Cleaning	<p>To bake on up to three shelf positions at the same time and to dry food.</p> <p>Set the temperature 20 - 40 °C lower than for Conventional Cooking.</p> <p>To add humidity during the cooking. To get the right colour and crispy crust during baking. To give more juiciness during reheating.</p> <p>Refer to "Care and cleaning" chapter for more information about: Aqua Cleaning.</p>
 Grill	To grill thin pieces of food and to toast bread.
 Turbo Grilling	To roast large meat joints or poultry with bones on one shelf position. To make gratins and to brown.

 The lamp may turn off automatically at a temperature below 60 °C during some oven functions.

## 6.4 Notes on: Moist Baking



This function was used to comply with the energy efficiency class and ecodesign requirements according to EU 65/2014 and EU 66/2014. Tests according to EN 60350-1.

The oven door should be closed during cooking so that the function is not interrupted and the oven operates with the highest energy efficiency possible.















For the cooking instructions refer to "Hints and tips" chapter, Moist Baking. For general energy saving recommendations refer to "Energy Efficiency" chapter, Energy Saving.

## 7. CLOCK FUNCTIONS

### 7.1 Clock functions

Clock function	Application
 Time of Day	To set, change or check the time of day.
 Duration	To set how long the oven works.
 Minute Minder	To set a countdown. This function has no effect on the operation of the oven. You can set this function at any time, also when the oven is off.

### 7.2 How to set: Clock functions

How to change: Time of Day	
 - flashes when you connect the oven to the electrical supply, when there was a power cut or when the timer is not set.	
Step 1	 - press repeatedly.  - starts to flash.
Step 2	 ,  - press to set the time. After approximately 5 sec., the flashing stops and the display shows the time.
 - press repeatedly to change the time of day.  - starts to flash.	
How to set: Duration	
Step 1	Set an oven function and the temperature.
Step 2	 - press repeatedly.  - starts to flash.
Step 3	 ,  - press to set the duration. The display shows:   - flashes when the set time ends. The signal sounds and the oven turns off.
Step 4	Press any button to stop the signal.
Step 5	Turn the knobs to the off position.
How to set: Minute Minder	
Step 1	 - press repeatedly.  - starts to flash.

#### How to set: Minute Minder

Step 2 **+**, **-** - press to set the time.  
The function starts automatically after 5 sec.  
When the set time ends, the signal sounds.

Step 3 Press any button to stop the signal.

Step 4 Turn the knobs to the off position.

#### How to cancel: Clock functions

Step 1  - press repeatedly until the clock function symbol starts to flash.

Step 2 Press and hold: **—**.  
The clock function turns off after few seconds.

## 8. USING THE ACCESSORIES



**WARNING!**  
Refer to Safety chapters.

devices. The high rim around the shelf prevents cookware from slipping of the shelf.

### 8.1 Inserting accessories

A small indentation at the top increases safety. The indentations are also anti-tip

#### Wire shelf:

Push the shelf between the guide bars of the shelf support.

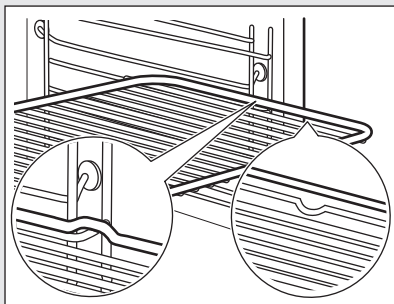

**Baking tray / Deep pan:**

Push the tray between the guide bars of the shelf support.

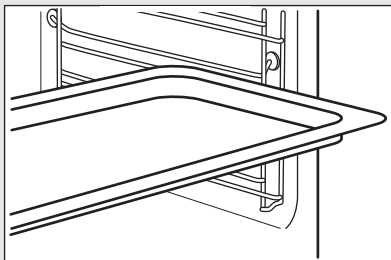
**Wire shelf, Baking tray / Deep pan:**

Push the tray between the guide bars of the shelf support and the wire shelf on the guide bars above.

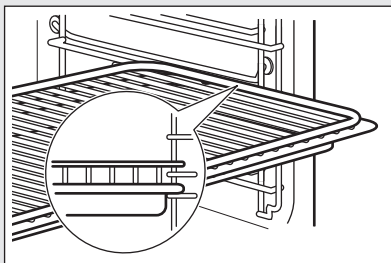

## 9. ADDITIONAL FUNCTIONS

### 9.1 Cooling fan

When the oven operates, the cooling fan turns on automatically to keep the surfaces of the oven cool. If you turn off the oven, the cooling fan can continue to operate until the oven cools down.

**CAUTION!**

Do not move the door lock vertically.

Do not push the door lock when you close the oven door.

### 9.2 Mechanical door lock

The door lock is unlocked when you buy the oven.

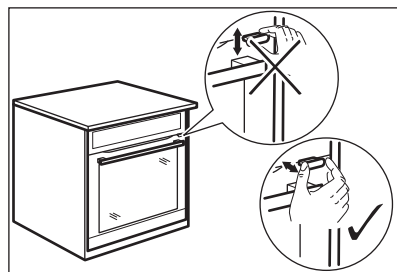
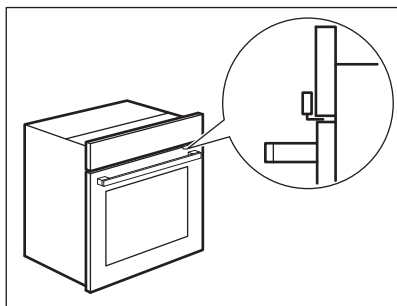

### 9.3 How to use mechanical door lock

1. To turn on the door lock pull the door lock forward until it locks in place.
2. To turn off the door lock push the door lock back into the panel.

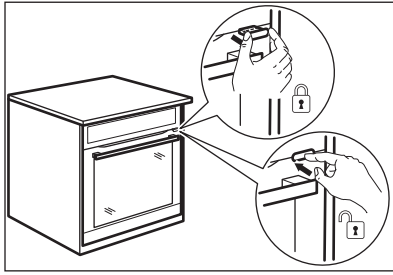

### 9.4 Opening the door with turned on mechanical door lock

You can open the door when the mechanical door lock is turned on.

1. Push the door lock slightly.

2. Open the door by pulling it with the handle.

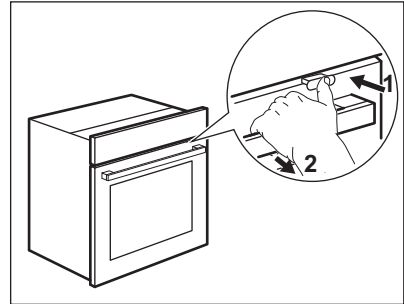

If you press the door lock until there is a click, you turn off the door lock.

## 10. HINTS AND TIPS



**WARNING!**  
Refer to Safety chapters.

### 10.1 Cooking recommendations



The temperature and cooking times in the tables are guidelines only. They depend on the recipes and the quality and quantity of the ingredients used.

Your oven may bake or roast differently to the oven you had before. The tables below show recommended settings for temperature, cooking time and shelf position for specific types of the food.

If you cannot find the settings for a special recipe, look for the similar one.

#### 10.2 Inner side of the door

On the inner side of the door you can find:





- the numbers of the shelf positions.
- information about the oven functions, recommended shelf positions and temperatures for dishes.

Use a baking tray.



#### 10.3 True Fan Cooking PLUS

Use the second shelf position.

CAKES / PASTRIES / BREADS	(ml)	(°C)	(min)
Cookies / Scones / Croissants	100	150 - 180	10 - 20



 CAKES / PASTRIES / BREADS	 (ml)	 (°C)	 (min)
Focaccia	100	200 - 210	10 - 20
Pizza	100	230	10 - 20
Bread rolls	100	200	20 - 25
Bread	100	180	35 - 40
Plum cake / Apple pie / Cinnamon rolls, baked in a cake mould	100 - 150	160 - 180	30 - 60



Use 150 ml of water unless specified otherwise.

 FROZEN READY MEALS	 (°C)	 (min)
Pizza	200 - 210	10 - 20
Croissants	170 - 180	15 - 25
Lasagne, use 200 ml	180 - 200	35 - 50

Use 100 ml of water.



Set the temperature to 110 °C.

 FOOD REGENERATION	 (min)
Bread rolls	10 - 20
Bread	15 - 25
Focaccia	15 - 25
Meat	15 - 25
Pasta	15 - 25
Pizza	15 - 25
Rice	15 - 25

 FOOD REGENERATION	 (min)
Vegetables	15 - 25

Use 200 ml of water.

Use a glass baking dish.

 ROASTING	 (°C)	 (min)
Roast beef	200	50 - 60
Chicken	210	60 - 80
Roast pork	180	65 - 80

## 10.4 Baking

For the first baking, use the lower temperature.

You can extend the baking time by 10 – 15 minutes if you bake cakes on more than one shelf position.





Cakes and pastries at different heights do not always brown equally. There is no need to change the temperature setting if an unequal browning occurs. The differences equalize during baking.

Trays in the oven can distort during baking. When the trays are cold again, the distortions disappear.

## 10.5 Tips on baking

Baking results	Possible cause	Remedy
The bottom of the cake is not baked sufficiently.	The shelf position is incorrect.	Put the cake on a lower shelf.
The cake sinks and becomes soggy or streaky.	The oven temperature is too high.	Next time set slightly lower oven temperature.
	The oven temperature is too high and the baking time is too short.	Next time set a longer baking time and lower oven temperature.
The cake is too dry.	The oven temperature is too low.	Next time set higher oven temperature.
	The baking time is too long.	Next time set shorter baking time.
The cake bakes unevenly.	The oven temperature is too high and the baking time is too short.	Next time set a longer baking time and lower oven temperature.
	The cake batter is not evenly distributed.	Next time spread the cake batter evenly on the baking tray.
The cake is not ready in the baking time specified in a recipe.	The oven temperature is too low.	Next time set a slightly higher oven temperature.

## 10.6 Baking on one shelf level



 BAKING IN TINS		 (°C)	 (min)	
Flan base - short pastry, preheat the empty oven	True Fan Cooking	170 - 180	10 - 25	2
Flan base - sponge cake mixture	True Fan Cooking	150 - 170	20 - 25	2
Ring cake / Brioche	True Fan Cooking	150 - 160	50 - 70	1
Madeira cake / Fruit cakes	True Fan Cooking	140 - 160	70 - 90	1
Cheesecake	Conventional Cooking	170 - 190	60 - 90	1

Use the third shelf position.

Use the function: True Fan Cooking.

Use a baking tray.







 CAKES / PASTRIES / BREADS	 (°C)	 (min)
Cake with crumble topping	150 - 160	20 - 40
Fruit flans (made of yeast dough / sponge cake mixture), use a deep pan	150	35 - 55
Fruit flans made of short pastry	160 - 170	40 - 80





Preheat the empty oven.

Use the function: Conventional Cooking.

Use a baking tray.





 CAKES / PASTRIES / BREADS	 (°C)	 (min)	
Swiss roll	180 - 200	10 - 20	3
Rye bread:	first: 230	20	1
	then: 160 - 180	30 - 60	
Buttered almond cake / Sugar cakes	190 - 210	20 - 30	3
Cream puffs / Eclairs	190 - 210	20 - 35	3
Plaited bread / Bread crown	170 - 190	30 - 40	3
Fruit flans (made of yeast dough / sponge cake mixture), use a deep pan	170	35 - 55	3
Yeast cakes with delicate toppings (e.g. quark, cream, custard)	160 - 180	40 - 80	3
Christstollen	160 - 180	50 - 70	2

Use the third shelf position.

 BISCUITS		 (°C)	 (min)
Short pastry biscuits	True Fan Cooking	150 - 160	10 - 20
Rolls, preheat the empty oven	True Fan Cooking	160	10 - 25
Biscuits made of sponge cake mixture	True Fan Cooking	150 - 160	15 - 20
Puff pastries, preheat the empty oven	True Fan Cooking	170 - 180	20 - 30
Biscuits made of yeast dough	True Fan Cooking	150 - 160	20 - 40
Macaroons	True Fan Cooking	100 - 120	30 - 50
Pastries made of egg white / Meringues	True Fan Cooking	80 - 100	120 - 150
Rolls, preheat the empty oven	Conventional Cooking	190 - 210	10 - 25

## 10.7 Bakes and gratins





Use the first shelf position.





		 (°C)	 (min)
Baguettes topped with melted cheese	True Fan Cooking	160 - 170	15 - 30
Vegetables au gratin, preheat the empty oven	Turbo Grilling	160 - 170	15 - 30
Lasagne	Conventional Cooking	180 - 200	25 - 40
Fish bakes	Conventional Cooking	180 - 200	30 - 60
Stuffed vegetables	True Fan Cooking	160 - 170	30 - 60
Sweet bakes	Conventional Cooking	180 - 200	40 - 60
Pasta bake	Conventional Cooking	180 - 200	45 - 60

## 10.8 Multilevel Baking

Use the baking trays.

Use the function: True Fan Cooking.

 CAKES / PASTRIES	 (°C)	 (min)	 2 positions
Cream puffs / Eclairs, preheat the empty oven	160 - 180	25 - 45	1 / 4
Dry streusel cake	150 - 160	30 - 45	1 / 4

 BIS-CUITS / SMALL CAKES / PASTRIES / ROLLS	 (°C)	 (min)	 2 positions	 3 positions
Rolls	180	20 - 30	1 / 4	-
Short pastry biscuits	150 - 160	20 - 40	1 / 4	1 / 3 / 5
Biscuits made of sponge cake mixture	160 - 170	25 - 40	1 / 4	-
Puff pastries, preheat the empty oven	170 - 180	30 - 50	1 / 4	-
Biscuits made of yeast dough	160 - 170	30 - 60	1 / 4	-
Macaroons	100 - 120	40 - 80	1 / 4	-
Biscuits made of egg white / Meringues	80 - 100	130 - 170	1 / 4	-

## 10.9 Tips on Roasting

Use heat-resistant ovenware.

Roast lean meat covered (you can use aluminium foil).

Roast large meat joints directly in the tray or on the wire shelf placed above the tray.

Put some water in the tray to prevent dripping fat from burning.







Turn the roast after 1/2 - 2/3 of the cooking time.







Roast meat and fish in large pieces (1 kg or more).







Baste meat joints with their own juice several times during roasting.



















## 10.10 Roasting







Use the first shelf position.







 BEEF				
			 (°C)	 (min)
Pot roast	1 - 1.5 kg	Conventional Cooking	230	120 - 150
Roast beef or fillet, rare, preheat the empty oven	per cm of thickness	Turbo Grilling	190 - 200	5 - 6
Roast beef or fillet, medium, preheat the empty oven	per cm of thickness	Turbo Grilling	180 - 190	6 - 8
Roast beef or fillet, well done, preheat the empty oven	per cm of thickness	Turbo Grilling	170 - 180	8 - 10

 PORK				
 Use the function: Turbo Grilling.				
	 (kg)	 (°C)	 (min)	
Shoulder / Neck / Ham joint	1 - 1.5	160 - 180	90 - 120	
Chops / Spare rib	1 - 1.5	170 - 180	60 - 90	
Meatloaf	0.75 - 1	160 - 170	50 - 60	
Pork knuckle, precooked	0.75 - 1	150 - 170	90 - 120	





 VEAL				
 Use the function: Turbo Grilling.				
	 (kg)	 (°C)	 (min)	
Roast veal	1	160 - 180	90 - 120	





 VEAL			
 Use the function: Turbo Grilling.			
	 (kg)	 (°C)	 (min)
Veal knuckle	1.5 - 2	160 - 180	120 - 150
 LAMB			
 Use the function: Turbo Grilling.			
	 (kg)	 (°C)	 (min)
Lamb leg / Roast lamb	1 - 1.5	150 - 170	100 - 120
Lamb saddle	1 - 1.5	160 - 180	40 - 60
 GAME			
 Use the function: Conventional Cooking.			
	 (kg)	 (°C)	 (min)
Saddle / Hare leg, preheat the empty oven	up to 1	230	30 - 40
Venison saddle	1.5 - 2	210 - 220	35 - 40
Haunch of venison	1.5 - 2	180 - 200	60 - 90





 POULTRY			
 Use the function: Turbo Grilling.			
	 (kg)	 (°C)	 (min)
Poultry, portions	0.2 - 0.25 each	200 - 220	30 - 50
Chicken, half	0.4 - 0.5 each	190 - 210	35 - 50
Chicken, poulard	1 - 1.5	190 - 210	50 - 70
Duck	1.5 - 2	180 - 200	80 - 100
Goose	3.5 - 5	160 - 180	120 - 180
Turkey	2.5 - 3.5	160 - 180	120 - 150
Turkey	4 - 6	140 - 160	150 - 240







 FISH (STEAMED)			
 Use the function: Conventional Cooking.			
	 (kg)	 (°C)	 (min)
Whole fish	1 - 1.5	210 - 220	40 - 60







## 10.11 Crispy baking with: Pizza Function

 PIZZA		
 Use the first shelf position.		
	 (°C)	 (min)
Tarts	180 - 200	40 - 55
Spinach flan	160 - 180	45 - 60

 PIZZA		
 Use the first shelf position.		
	 (°C)	 (min)
Quiche lorraine / Swiss flan	170 - 190	45 - 55
Cheesecake	140 - 160	60 - 90







 PIZZA		
 Use the first shelf position.		
	 (°C)	 (min)
Vegetable pie	160 - 180	50 - 60







 PIZZA		
 Preheat the empty oven before cooking.		
 Use the second shelf position.		
	 (°C)	 (min)
Pizza, thin crust, use a deep pan	200 - 230	15 - 20
Pizza, thick crust	180 - 200	20 - 30

 PIZZA		
 Preheat the empty oven before cooking.		
 Use the second shelf position.		
	 (°C)	 (min)
Unleavened bread	230 - 250	10 - 20
Puff pastry flan	160 - 180	45 - 55
Flammkuchen	230 - 250	12 - 20
Pierogi	180 - 200	15 - 25







### 10.12 Grill

Preheat the empty oven before cooking.  
Grill only thin pieces of meat or fish.  
Put a pan on the first shelf position to collect fat.

 GRILL				
 Use the function: Grill				
	 (°C)	 (min) 1st side	 (min) 2nd side	
Roast beef	210 - 230	30 - 40	30 - 40	2
Beef fillet	230	20 - 30	20 - 30	3
Pork loin	210 - 230	30 - 40	30 - 40	2

 GRILL				
 Use the function: Grill				
	 (°C)	 (min) 1st side	 (min) 2nd side	
Veal loin	210 - 230	30 - 40	30 - 40	2
Lamb saddle	210 - 230	25 - 35	20 - 25	3
Whole fish, 0.5 kg - 1 kg	210 - 230	15 - 30	15 - 30	3 / 4

### 10.13 Frozen Foods

 DEFROSTING				
 Use the function: True Fan Cooking.				
	 (°C)	 (min)		
Pizza, frozen	200 - 220	15 - 25	2	
Pizza American, frozen	190 - 210	20 - 25	2	
Pizza, chilled	210 - 230	13 - 25	2	
Pizza snacks, frozen	180 - 200	15 - 30	2	
French fries, thin	200 - 220	20 - 30	3	
French fries, thick	200 - 220	25 - 35	3	
Wedges / Croquettes	220 - 230	20 - 35	3	
Hash browns	210 - 230	20 - 30	3	
Lasagne / Cannelloni, fresh	170 - 190	35 - 45	2	
Lasagne / Cannelloni, frozen	160 - 180	40 - 60	2	
Baked cheese	170 - 190	20 - 30	3	
Chicken wings	190 - 210	20 - 30	2	



## 10.14 Defrost





Remove the food packaging and put the food on a plate.

Do not cover the food, as this can extend the defrost time.

For large portions of food place an upturned empty plate on the bottom of

Use the first shelf position.

the oven cavity. Put the food in a deep dish and set it on top of the plate inside the oven. Remove the shelf supports if necessary.

	 (kg)	 (min) Defrosting time	 (min) Further defrosting time	
Chicken	1	100 - 140	20 - 30	Turn halfway through.
Meat	1	100 - 140	20 - 30	Turn halfway through.
Trout	0.15	25 - 35	10 - 15	-
Strawberries	0.3	30 - 40	10 - 20	-
Butter	0.25	30 - 40	10 - 15	-
Cream	2 x 0.2	80 - 100	10 - 15	Whip the cream when still slightly frozen in places.
Gateau	1.4	60	60	-



## 10.15 Dehydrating - True Fan Cooking

Cover trays with grease proof paper or baking parchment.



For a better result, stop the oven halfway through the drying time, open the door and let it cool down for one night to complete the drying.



For 1 tray use the third shelf position.



For 2 trays use the first and fourth shelf position.

 VEGETABLES	 (°C)	 (h)
Peppers	60 - 70	5 - 6
Vegetables for soup	60 - 70	5 - 6
Mushrooms	50 - 60	6 - 8
Herbs	40 - 50	2 - 3

Set the temperature to 60 - 70 °C.



 VEGETABLES	 (°C)	 (h)
Beans	60 - 70	6 - 8

 FRUIT	 (h)
Plums	8 - 10

 FRUIT	 (h)
Apricots	8 - 10
Apple slices	6 - 8
Pears	6 - 9



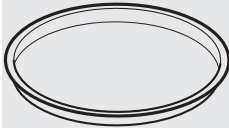
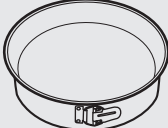

## 10.16 Moist Baking - recommended accessories





Use the dark and non-reflective tins and containers. They have better heat absorption than the light colour and reflective dishes.

			
Pizza pan	Baking dish	Ramekins	Flan base tin
Dark, non-reflective 28 cm diameter	Dark, non-reflective 26 cm diameter	Ceramic 8 cm diameter, 5 cm height	Dark, non-reflective 28 cm diameter

## 10.17 Moist Baking







For the best results follow suggestions listed in the table below.







		 (°C)		 (min)
Sweet rolls, 16 pieces	baking tray or dripping pan	190	3	45 - 55
Pizza, frozen, 0.35 kg	wire shelf	190	2	45 - 50
Swiss roll	baking tray or dripping pan	180	2	45 - 55
Brownie	baking tray or dripping pan	180	2	55 - 60
Sponge flan base	flan base tin on wire shelf	180	2	40 - 50
Poached fish, 0.3 kg	baking tray or dripping pan	180	3	25 - 35
Whole fish, 0.2 kg	baking tray or dripping pan	180	3	25 - 35
Fish fillet, 0.3 kg	pizza pan on wire shelf	180	3	40 - 50







		 (°C)		 (min)
Poached meat, 0.25 kg	baking tray or dripping pan	190	3	40 - 50
Shashlik, 0.5 kg	baking tray or dripping pan	190	3	35 - 45
Cookies, 16 pieces	baking tray or dripping pan	160	2	40 - 50
Macaroons, 24 pieces	baking tray or dripping pan	150	2	35 - 45
Muffins, 12 pieces	baking tray or dripping pan	160	2	35 - 45
Savory pastry, 20 pieces	baking tray or dripping pan	170	2	35 - 45
Short crust biscuits, 20 pieces	baking tray or dripping pan	150	2	40 - 45
Tartlets, 8 pieces	baking tray or dripping pan	170	2	35 - 45
Vegetables, poached, 0.4 kg	baking tray or dripping pan	180	3	45 - 55
Vegetarian omelette	pizza pan on wire shelf	190	3	40 - 50







## 10.18 Information for test institutes







Tests according to: EN 60350, IEC 60350.

 BAKING ON ONE LEVEL. Baking in tins				
		 (°C)	 (min)	
Fatless sponge cake	True Fan Cooking	140 - 150	35 - 50	2
Fatless sponge cake	Conventional Cooking	160	35 - 50	2
Apple pie, 2 tins Ø20 cm	True Fan Cooking	160	60 - 90	2

 <b>BAKING ON ONE LEVEL. Baking in tins</b>					
		 (°C)	 (min)		
Apple pie, 2 tins Ø20 cm	Conventional Cook- ing	180	70 - 90	1	

 <b>BAKING ON ONE LEVEL. Biscuits</b>					
 Use the third shelf position.					
		 (°C)	 (min)		
Short bread / Pastry strips	True Fan Cooking	140	25 - 40		
Short bread / Pastry strips, preheat the empty oven	Conventional Cooking	160	20 - 30		
Small cakes, 20 per tray, preheat the empty oven	True Fan Cooking	150	20 - 35		
Small cakes, 20 per tray, preheat the empty oven	Conventional Cooking	170	20 - 30		

 <b>MULTILEVEL BAKING. Biscuits</b>					
		 (°C)	 (min)		
Short bread / Pastry strips	True Fan Cooking	140	25 - 45	1 / 4	
Small cakes, 20 per tray, preheat the empty oven	True Fan Cooking	150	23 - 40	1 / 4	
Fatless sponge cake	True Fan Cooking	160	35 - 50	1 / 4	

 GRILL			
 Preheat the empty oven for 5 minutes.			
 Grill with the maximum temperature setting.			
		 (min)	
Toast	Grill	1 - 3	5
Beef steak, turn halfway through	Grill	24 - 30	4

## 11. CARE AND CLEANING

 **WARNING!**  
Refer to Safety chapters.

### 11.1 Notes on cleaning

 Cleaning Agents	Clean the front of the oven with a soft cloth with warm water and a mild detergent.
	Use a cleaning solution to clean metal surfaces.
	Clean stains with a mild detergent.

 Everyday Use	Clean the cavity after each use. Fat accumulation or other residue may cause fire.
	Do not store the food in the oven for longer than 20 minutes. Dry the cavity with a soft cloth after each use.

 Accessories	Clean all accessories after each use and let them dry. Use a soft cloth with warm water and a mild detergent. Do not clean the accessories in a dishwasher.
	Do not clean the non-stick accessories using abrasive cleaner or sharp-edged objects.

## 11.2 How to clean: Cavity embossment

Clean the cavity embossment to remove limestone residue after cooking with steam.

Step 1	Step 2	Step 3
Pour: 250 ml of white vinegar into the cavity embossment. Use maximum 6% vinegar without any additives.	Let the vinegar dissolve the limestone residue at the ambient temperature for 30 minutes.	Clean the cavity with warm water and a soft cloth.
For the function: True Fan Cooking PLUS clean the oven for every 5 - 10 cooking cycles.		

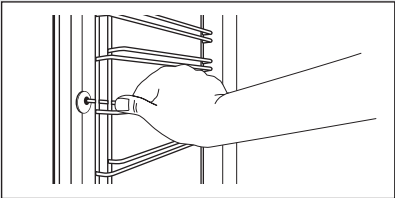
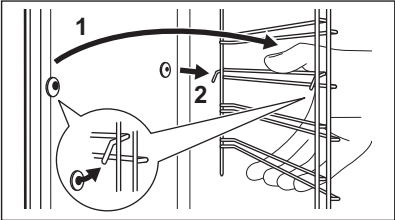

## 11.3 How to remove: Shelf supports

Remove the shelf supports to clean the oven.

Step 1	Turn off the oven and wait until it is cold.	
Step 2	Pull the front of the shelf support away from the side wall.	
Step 3	Pull the rear end of the shelf support away from the side wall and remove it.	
Step 4	Install the shelf supports in the opposite sequence.	

## 11.4 How to use: Aqua Cleaning

This cleaning procedure uses humidity to remove remaining fat and food particles from the oven.

Step 1	Pour water into the cavity embossment: 200 ml.
Step 2	Set the function:   .

Step 3	Set the temperature to 90 °C.
Step 4	Let the oven work for 30 min.
Step 5	Turn off the oven.
Step 6	Wait until the oven is cold. Dry the cavity with a soft cloth.

## 11.5 How to remove: Grill



**WARNING!**  
There is a risk of burns.

Step 1	Turn off the oven and wait until it is cold to clean it. Remove the shelf supports.	
Step 2	Grab the grill corners. Pull it forwards against the spring pressure and out of two holders. The grill folds down.	
Step 3	Clean the oven ceiling with warm water, a soft cloth and a mild detergent. Let it dry.	
Step 4	Install the grill in the opposite sequence.	
Step 5	Install the shelf supports.	

## 11.6 How to remove and install:

The number of glass panels is different for different models.



**CAUTION!**  
Carefully handle the glass, especially around the edges of the front panel. The glass can break.

## 11.7 How to replace: Lamp



**WARNING!**  
Risk of electric shock.  
The lamp can be hot.

Before you replace the lamp:

Step 1	Step 2	Step 3
Turn off the oven. Wait until the oven is cold.	Disconnect the oven from the mains.	Put a cloth on the bottom of the cavity.

## Top lamp

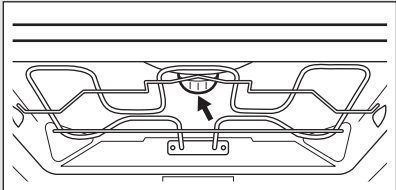
Step 1	Turn the glass cover to remove it.	
Step 2	Clean the glass cover.	
Step 3	Replace the lamp with a suitable 300 °C heat-resistant lamp.	
Step 4	Install the glass cover.	

## 12. TROUBLESHOOTING



**WARNING!**  
Refer to Safety chapters.

### 12.1 What to do if...

In any cases not included in this table please contact with an Authorised Service Centre.

Problem	Check if...
The oven does not heat up.	The fuse is blown.
The display shows "12.00".	There was a power cut. Set the time of day.
The water leaks out of the cavity embossment.	There is too much water in the cavity embossment.

Problem	Check if...
Unsatisfying cooking performance of the function: True Fan Cooking PLUS .	You filled the cavity embossment with water.
The lamp does not work.	The lamp is burnt out.

### 12.2 Service data

If you cannot find a solution to the problem yourself, contact your dealer or an Authorised Service Centre.

The necessary data for the service centre is on the rating plate. The rating plate is on the front frame of the oven cavity. Do not remove the rating plate from the oven cavity.

We recommend that you write the data here:	
Model (MOD.)	.....
Product number (PNC)	.....
Serial number (S.N.)	.....



## 13. ENERGY EFFICIENCY

### 13.1 Product Information and Product Information Sheet\*

Supplier's name	AEG	
Model identification	BEB351010M 944188349 BEB351010W 944188350	
Energy Efficiency Index	95.3	
Energy efficiency class	A	
Energy consumption with a standard load, conventional mode	0.99 kWh/cycle	
Energy consumption with a standard load, fan-forced mode	0.81 kWh/cycle	
Number of cavities	1	
Heat source	Electricity	
Volume	71 l	
Type of oven	Built-In Oven	
Mass	BEB351010M	34.0 kg
	BEB351010W	34.0 kg

\* For European Union according to EU Regulations 65/2014 and 66/2014.  
For Republic of Belarus according to STB 2478-2017, Appendix G; STB 2477-2017, Annexes A and B.  
For Ukraine according to 568/32020.

Energy efficiency class is not applicable for Russia.

EN 60350-1 - Household electric cooking appliances - Part 1: Ranges, ovens, steam ovens and grills - Methods for measuring performance.

### 13.2 Energy saving



The oven has features which help you save energy during everyday cooking.

Make sure that the oven door is closed when the oven operates. Do not open the oven door too often during cooking. Keep the door gasket clean and make sure it is well fixed in its position.

Use metal cookware to improve energy saving.

When possible, do not preheat the oven before cooking.

Keep breaks between baking as short as possible when you prepare a few dishes at one time.

**Cooking with fan**  
When possible, use the cooking functions with fan to save energy.

**Residual heat**  
When the cooking duration is longer than 30 min, reduce the oven temperature to minimum 3 - 10 min before the end of cooking. The residual heat inside the oven will continue to cook.

Use the residual heat to warm up other dishes.

Keep food warm  
Choose the lowest possible temperature setting to use residual heat and keep a meal warm.

Moist Baking  
Function designed to save energy during cooking.

## 14. ENVIRONMENTAL CONCERNS

Recycle materials with the symbol . Put the packaging in relevant containers to recycle it. Help protect the environment and human health by recycling waste of electrical and electronic appliances. Do not dispose of

appliances marked with the symbol  with the household waste. Return the product to your local recycling facility or contact your municipal office.



[www.aeg.com/shop](http://www.aeg.com/shop)



867336370-G-162020



**AEG**